

**SERVICE PARTS MANUAL  
CIM SERIES**

**CIM0330, CIM0430, CIM0436, CIM0530 and CIM0636  
CIM0335, CIM0435, CIM0535 and CIM0635**





This parts list contains the service parts available for the following CIM Series.

<b>CIM0330</b>	<b>115/60/1</b>	<b>CIM0335</b>	<b>220-240/50/1</b>
<b>CIM0430</b>	<b>115/60/1</b>		
<b>CIM0436</b>	<b>208-230/60/1</b>	<b>CIM0435</b>	<b>220-240/50/1</b>
<b>CIM0530</b>	<b>115/60/1</b>	<b>CIM0535</b>	<b>220-240/50/1</b>
<b>CIM0636</b>	<b>208-230/60/1</b>	<b>CIM0635</b>	<b>220-240/50/1</b>

**Model Number Example**

**CIM0330HA**

**CIM** = **C**uber **I**ce **M**achine

**03** = 300 lb, in 24 hours capacity

**3** = 30 inch wide cabinet

**0** = 115 Volt, **5** = 220-240/50/1 **6** = 208-230/60/1 Volt

**H** = Half Cube Size, **F** = Full Cube Size

**A** = Air Cooled Condenser, **W** = Water Cooled Condenser **R**=Remote Condenser

**Check the model number on the data plate and refer to the correct listing for the specific component.**

Check carefully that the correct part is identified and ordered.

<b>Table of Contents</b>	<b>Page 1</b>
<b>Cabinet</b>	<b>Page 2-3</b>
<b>Water System</b>	<b>Page 4-5</b>
<b>Air Cooled Condenser</b>	<b>Page 6-7</b>
<b>Water Cooled Condenser</b>	<b>Page 8-9</b>
<b>Remote Condenser</b>	<b>Page 10-11</b>
<b>Electrical</b>	<b>Page 12-13</b>

Ice-O-Matic  
 11100 East 45th Ave.  
 Denver Co. 80239  
 800-423-3367

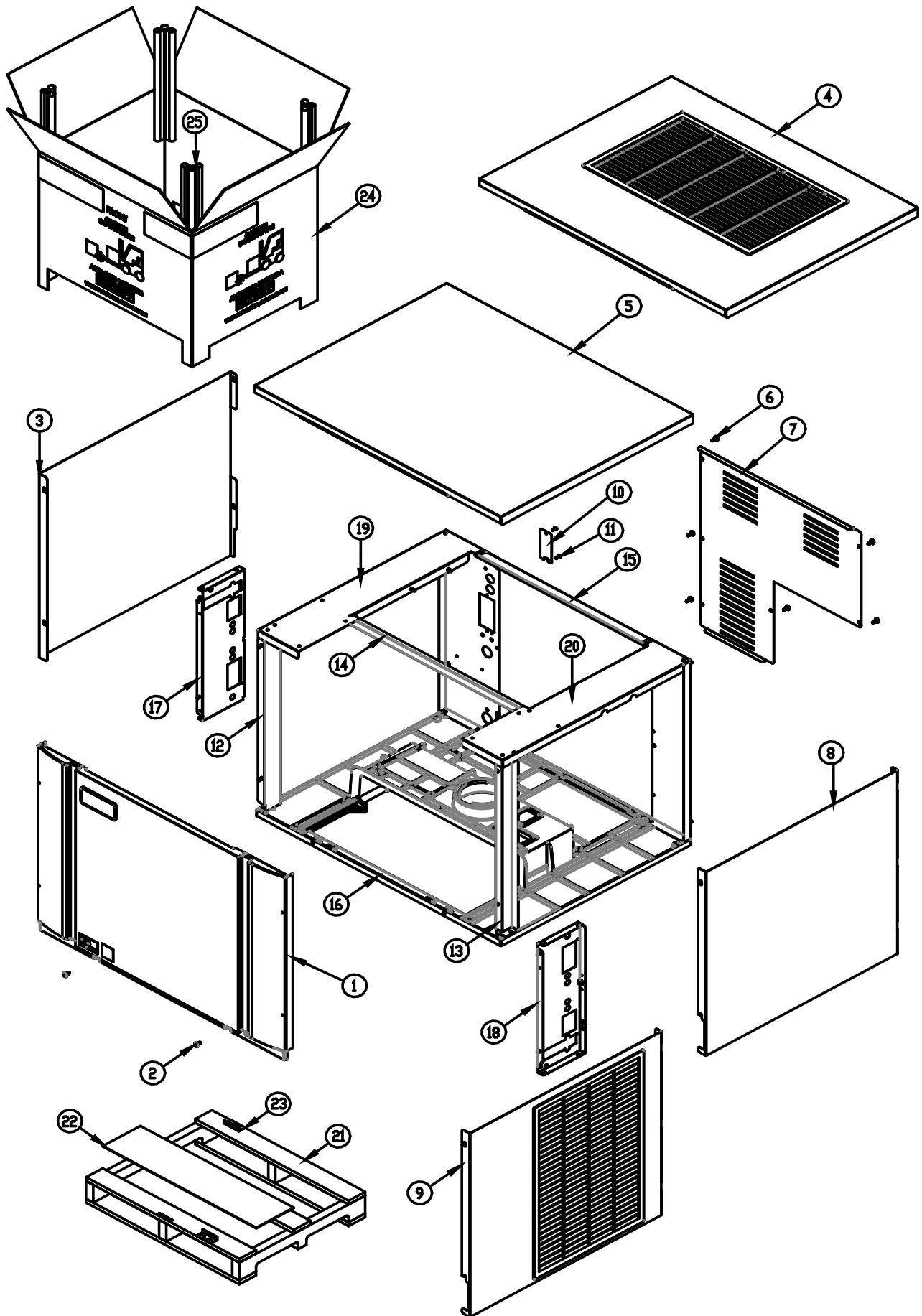

Item No.	Model Number					Description
	CIM0330	CIM0430	CIM0436	CIM0530	CIM0636	
1	2031540-01S	2031540-01S	2031540-01S	2031540-01S	2031540-01S	Front Panel
2	9031237-01	9031237-01	9031237-01	9031237-01	9031237-01	Front Panel Screws
3	3022007-02	3022007-02	3022007-02	3022007-02	3022007-02	Left Side Side Panel
4	2101496-02S	2101496-02S	2101496-02S	2101496-02S	2101496-02S	Top Panel-Air Cooled
5	3022012-03	3022012-03	3022012-03	3022012-03	3022012-03	Top Panel-Remote and Water Cooled
6	9031046-01	9031046-01	9031046-01	9031046-01	9031046-01	Rear Cover Screws
7	3013634-01	3013634-01	3013634-01	3013634-01	3013634-01	Rear Cover
8	3022007-03	3022007-03	3022007-03	3022007-03	3022007-03	Right Side Panel-Remote and Water Cooled
9	2101495-01S	2101495-01S	2101495-01S	2101495-01S	2101495-01S	Right Side Panel-Air Cooled
10	3013674-01	3013674-01	3013674-01	3013674-01	3013674-01	Junction Box Cover
11	9031046-01	9031046-01	9031046-01	9031046-01	9031046-01	Junction Box Screw
12	2021786-01	2021786-01	2021786-01	2021786-01	2021786-01	Left Front Corner Post
13	2021786-02	2021786-02	2021786-02	2021786-02	2021786-02	Right Front Corner post
14	3013637-02	3013637-02	3013637-02	3013637-02	3013637-02	Brace 30 Inch
15	3013636-01	3013636-01	3013636-01	3013636-01	3013636-01	Rear Brace
16	9051725-02	9051725-02	9051725-02	9051725-02	9051725-02	Base
17	2021784-01	2021784-01	2021784-01	2021784-01	2021784-01	Front Left Brace
18	2021785-01	2021785-01	2021785-01	2021785-01	2021785-01	Front Right Brace
19	2021780-01	2021780-01	2021780-01	2021780-01	2021780-01	Right Side Framework 30"Assembly
20	2021781-01	2021781-01	2021781-01	2021781-01	2021781-01	Left Side Framework 30"Assembly
21	9011369-02	9011369-02	9011369-02	9011369-02	9011369-02	Elevation Skid 30 Inch
22	9011378-01	9011378-01	9011378-01	9011378-01	9011378-01	Carton Liner 30 Inch
23	9051765-01	9051765-01	9051765-01	9051765-01	9051765-01	Shipping Bracket 2 Req. (Field Installed)
24	9011374-02	9011374-02	9011374-02	9011374-02	9011374-02	Carton, Elevation 30 Inch
25	9011320-15	9011320-15	9011320-15	9011320-15	9011320-15	Corner Post (Each), Elevation, (4 Required)
	9031026-04P	9031026-04P	9031026-04P	9031026-04P	9031026-04P	Pop Rivets Not Shown ( Package of 10)

	CIM0335		CIM0435	CIM0535	CIM0635	Description
1	2031540-01S		2031540-01S	2031540-01S	2031540-01S	Front Panel
2	9031237-01		9031237-01	9031237-01	9031237-01	Front Panel Screws
3	3022007-02		3022007-02	3022007-02	3022007-02	Left Side Side Panel
4	2101496-02S		2101496-02S	2101496-02S	2101496-02S	Top Panel-Air Cooled
5	Not Used		Not Used	3022012-03	3022012-03	Top Panel-Remote and Water Cooled
6	9031046-01		9031046-01	9031046-01	9031046-01	Rear Cover Screws
7	3013634-01		3013634-01	3013634-01	3013634-01	Rear Cover
8	Not Used		Not Used	3022007-03	3022007-03	Right Side Panel-Remote and Water Cooled
9	2101495-01S		2101495-01S	2101495-01S	2101495-01S	Right Side Panel-Air Cooled
10	3013674-01		3013674-01	3013674-01	3013674-01	Junction Box Cover
11	9031046-01		9031046-01	9031046-01	9031046-01	Junction Box Screw
12	2021786-01		2021786-01	2021786-01	2021786-01	Left Front Corner Post
13	2021786-02		2021786-02	2021786-02	2021786-02	Right Front Corner post
14	3013637-02		3013637-02	3013637-02	3013637-02	Brace 30 Inch
15	3013636-01		3013636-01	3013636-01	3013636-01	Rear Brace
16	9051725-02		9051725-02	9051725-02	9051725-02	Base
17	2021784-01		2021784-01	2021784-01	2021784-01	Front Left Brace
18	2021785-01		2021785-01	2021785-01	2021785-01	Front Right Brace
19	2021780-01		2021780-01	2021780-01	2021780-01	Right Side Framework 30"Assembly
20	2021781-01		2021781-01	2021781-01	2021781-01	Left Side Framework 30"Assembly
21	9011369-02		9011369-02	9011369-02	9011369-02	Elevation Skid 30 Inch
22	9011378-01		9011378-01	9011378-01	9011378-01	Carton Liner 30 Inch
23	9051765-01		9051765-01	9051765-01	9051765-01	Shipping Bracket 2 Req. (Field Installed)
24	9011374-02		9011374-02	9011374-02	9011374-02	Carton, Elevation 30 Inch
25	9011320-15		9011320-15	9011320-15	9011320-15	Corner Post (Each), Elevation, (4 Required)
	9031026-04P		9031026-04P	9031026-04P	9031026-04P	Pop Rivets Not Shown ( Package of 10)

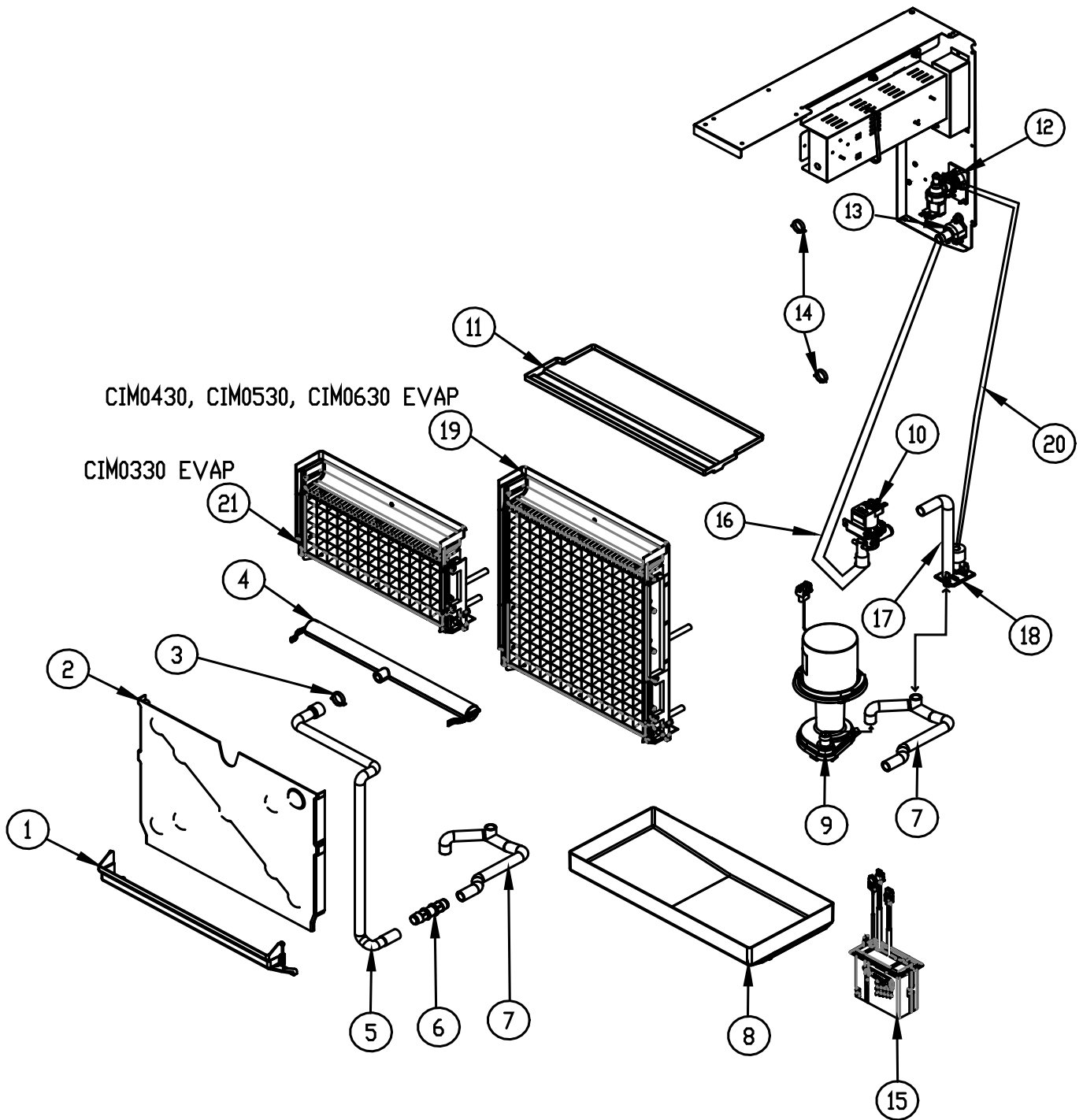

The Model Number of the machine has a designator for the Cube Size

Example: **CIM0430FA** **F = Full Cube**

**CIM0430HA** **H = Half Cube**

Item No.	Model Number					Description
	CIM0330	CIM0430	CIM0436	CIM0530	CIM0636	
1	9051736-01	9051736-01	9051736-01	9051736-01	9051736-01	Lower Curtain Assembly
2	9051726-01	9051726-02	9051726-02	9051726-02	9051726-02	Evaporator Cover
3	9021010-05	9021010-05	9021010-05	9021010-05	9021010-05	Hose Clamp, Plastic
4	9051766-01	9051766-01	9051766-01	9051766-01	9051766-01	Water Distribution Tube Assembly
5	9051479-01	9051479-02	9051479-02	9051479-02	9051479-02	Water Tube, Upper
6	9091177-01	9091177-01	9091177-01	9091177-01	9091177-01	Coupler, Straight, 5/8 I.D. Tubing
7	9051748-01	9051748-01	9051748-01	9051748-01	9051748-01	Water Tube, Sump
8	9051737-01	9051737-01	9051737-01	9051737-01	9051737-01	Sump/Water Trough
9	2062336-01	2062336-01	2062336-02	2062336-01	2062336-02	Water Pump
10	9041105-04	9041105-04	9041105-05	9041105-04	9041105-05	Purge Valve
11	9051738-01	9051738-01	9051738-01	9051738-01	9051738-01	Top Cover
12	9041108-01	9041108-01	9041108-02	9041108-01	9041108-02	Water Inlet Valve
13	9091140-01	9091140-01	9091140-01	9091140-01	9091140-01	Drain Fitting
14	9021010-04	9021010-04	9021010-04	9021010-04	9021010-04	Hose Clamp, Plastic
15	1051224-01	1051224-01	1051224-01	1051224-01	1051224-01	Float Switch Assembly (Includes Instructions)
16	3051269-30S	3051269-30S	3051269-30S	3051269-30S	3051269-30S	Purge Valve Tubing to Drain
17	9051541-01	9051541-01	9051541-01	9051541-01	9051541-01	Purge Valve Tube to Inlet Outlet Bracket
18	9051739-01	9051739-01	9051739-01	9051739-01	9051739-01	Inlet Outlet Bracket
19		2051298-03	2051298-03	2051298-03	2051298-03	Evaporator-FULL Cube = 7/8 x 7/8 x 7/8
19		2051298-04	2051298-04	2051298-04	2051298-04	Evaporator-HALF Cube = 3/8 x 7/8 x 7/8
20	9051270-36	9051270-36	9051270-36	9051270-36	9051270-36	Water Inlet Valve to Inlet Outlet Bracket Tube
21	2051298-01					Evaporator-FULL Cube = 7/8 x 7/8 x 7/8
21	2051298-02					Evaporator-HALF Cube = 3/8 x 7/8 x 7/8
	115/60/1	115/60/1	208-230/60/1	115/60/1	208-230/60/1	Machine Voltage

The Model Number of the machine has a designator for the Cube Size

Example: CIM0430FA      F = Full Cube      Cube Size = 7/8 x 7/8 x 7/8  
 CIM0430HA      H = Half Cube      Cube Size = 3/8 x 7/8 x 7/8

Item No.	Model Number 220-240/50/1					Description
	CIM0335		CIM0435	CIM0535	CIM0635	
1	9051736-01		9051736-01	9051736-01	9051736-01	Lower Curtain Assembly
2	9051726-01		9051726-02	9051726-02	9051726-02	Evaporator Cover
3	9021010-05		9021010-05	9021010-05	9021010-05	Hose Clamp, Plastic
4	9051766-01		9051766-01	9051766-01	9051766-01	Water Distribution Tube Assembly
5	9051479-01		9051479-02	9051479-02	9051479-02	Water Tube, Upper
6	9091177-01		9091177-01	9091177-01	9091177-01	Coupler, Straight, 5/8 I.D. Tubing
7	9051748-01		9051748-01	9051748-01	9051748-01	Water Tube, Sump
8	9051737-01		9051737-01	9051737-01	9051737-01	Sump/Water Trough
9	2062336-02		2062336-02	2062336-01	2062336-02	Water Pump
10	9041105-05		9041105-05	9041105-05	9041105-05	Purge Valve
11	9051738-01		9051738-01	9051738-01	9051738-01	Top Cover
12	9041108-01		9041108-02	9041108-01	9041108-02	Water Inlet Valve
13	9091140-01		9091140-01	9091140-01	9091140-01	Drain Fitting
14	9021010-04		9021010-04	9021010-04	9021010-04	Hose Clamp, Plastic
15	1051224-01		1051224-01	1051224-01	1051224-01	Float Switch Assembly (Includes Instructions)
16	3051269-30S		3051269-30S	3051269-30S	3051269-30S	Purge Valve Tubing to Drain
17	9051541-01		9051541-01	9051541-01	9051541-01	Purge Valve Tube to Inlet Outlet Bracket
18	9051739-01		9051739-01	9051739-01	9051739-01	Inlet Outlet Bracket
19			2051298-03	2051298-03	2051298-03	Evaporator-FULL Cube = 7/8 x 7/8 x 7/8
19			2051298-04	2051298-04	2051298-04	Evaporator-HALF Cube = 3/8 x 7/8 x 7/8
20	9051270-36		9051270-36	9051270-36	9051270-36	Water Inlet Valve to Inlet Outlet Bracket Tube
21	2051298-01					Evaporator-FULL Cube = 7/8 x 7/8 x 7/8
21	2051298-02					Evaporator-HALF Cube = 3/8 x 7/8 x 7/8

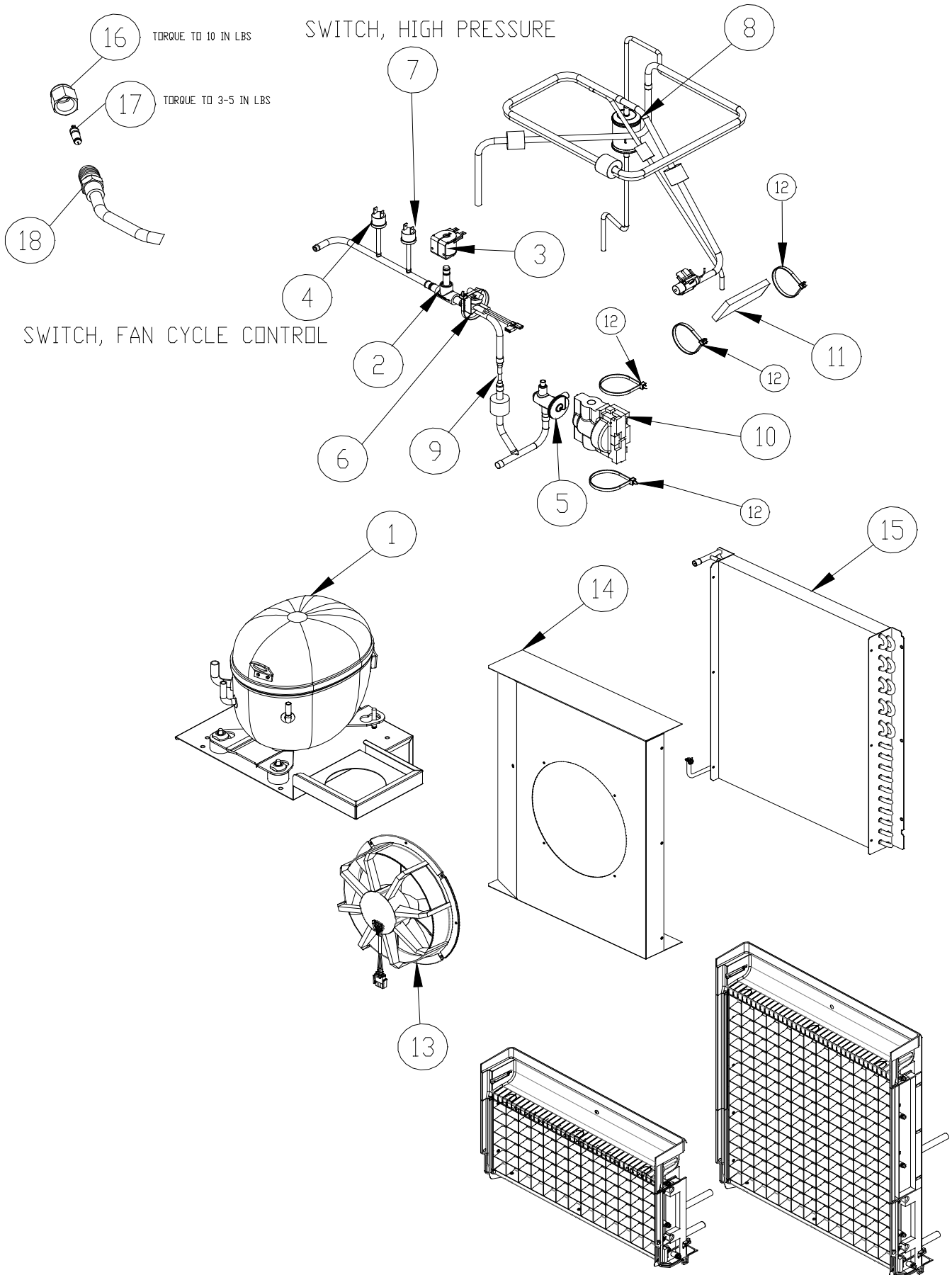

REFERENCE PAGE 4 AND 5 FOR EVAPORATOR



Item No.	Model Number					Description
	CIM0330A	CIM0430A	CIM0436A	CIM0530A	CIM0636A	
1	9181163-101	9181163-101	9181164-101	9181137-11B	9181145-11A	Compressor <b>See Below For Starting Components</b>
2	9151192-03	9151192-03	9151192-03	9151192-01	9151192-01	Hot Gas Valve Body
3	9151193-01	9151193-01	9151193-02	9151193-01	9151193-02	Hot Gas Valve Coil
4	9041106-01	9041106-01	9041106-01	9041106-01	9041106-01	Switch, Fan Cycle
5	9151154-01	9151149-01	9151149-01	9151149-01	9151149-01	TXV
6	9041098-02	9041098-02	9041098-02	9041098-02	9041098-02	High Temp Switch
7	9041111-01	9041111-01	9041111-01	9041111-01	9041111-01	Switch, High Pressure
8	9151163-01	9151163-01	9151163-01	9151163-01	9151163-01	Drier
9	9091179-01	9091179-01	9091179-01	9091179-01	Not Used	Restrictor
10	9131544-01	9131544-01	9131544-01	9131544-01	9131544-01	Insulation, TXV
11	9131143-07	9131143-07	9131143-07	9131143-07	9131143-07	Insulation, Bulb
12	9021021-01	9021021-01	9021021-01	9021021-01	9021021-01	Cable Tie-For TXV and Bulb Insulation
13	9161135-01	9161135-01	9161135-02	9161135-01	9161135-02	Fan Motor Assembly
14	3013639-01	3013639-01	3013639-01	3013639-01	3013639-01	Fan Shroud
15	9141152-01	9141152-01	9141152-01	9141152-01	9141152-01	Condenser
16	9091086-03	9091086-03	9091086-03	9091086-03	9091086-03	Service Valve Cap
17	9091086-02	9091086-02	9091086-02	9091086-02	9091086-02	Service Valve Core
18	9091086-01	9091086-01	9091086-01	9091086-01	9091086-01	Service Valve Stem
	<b>115/60/1</b>	<b>115/60/1</b>	<b>208-230/60/1</b>	<b>115/60/1</b>	<b>208-230/60/1</b>	<b>Machine Voltage</b>
	<b>CIM0330A</b>	<b>CIM0430A</b>	<b>CIM0436A</b>	<b>CIM0530A</b>	<b>CIM0636A</b>	<b>Starting Components</b>
	<b>9181163-101</b>	9181163-101	<b>9181164-101</b>	9181137-11B	<b>9181145-11A</b>	Compressor Kit
	<b>9181003-50</b>	9181003-50	<b>9181003-26</b>	9181003-50	<b>9181003-52</b>	Start Capacitor
	<b>9181009-25</b>	9181009-25	<b>9181009-08</b>	9181009-25	<b>9181009-19</b>	Run Capacitor
	<b>9181010-33</b>	9181010-33	<b>9181010-27</b>	9181010-14	<b>9181010-27</b>	Compressor Relay
	<b>9181005-49</b>	9181005-49	<b>9181005-50</b>	9181005-45	<b>Internal</b>	Overload

Item No.	Model Number 220-240/50/1					Description
	CIM0335A		CIM0435A	CIM0535A	CIM0635A	
1	9181165-101		9181138-11A	9181166-11	9181147-11	Compressor <b>See Below For Starting Components</b>
2	9151192-03		9151192-03	9151192-01	9151192-01	Hot Gas Valve Body
3	9151193-02		9151193-02	9151193-02	9151193-02	Hot Gas Valve Coil
4	9041106-01		9041106-01	9041106-01	9041106-01	Switch, Fan Cycle
5	9151154-01		9151149-01	9151149-01	9151149-01	TXV
6	9041098-02		9041098-02	9041098-02	9041098-02	High Temp Switch
7	9041111-01		9041111-01	9041111-01	9041111-01	Switch, High Pressure
8	9151163-01		9151163-01	9151163-01	9151163-01	Drier
9	9091179-01		9091179-01	9091179-01	Not Used	Restrictor
10	9131544-01		9131544-01	9131544-01	9131544-01	Insulation, TXV
11	9131143-07		9131143-07	9131143-07	9131143-07	Insulation, Bulb
12	9021021-01		9021021-01	9021021-01	9021021-01	Cable Tie-For TXV and Bulb Insulation
13	9161135-02		9161135-02	9161135-02	9161135-02	Fan Motor Assembly
14	3013639-01		3013639-01	3013639-01	3013639-01	Fan Shroud
15	9141152-01		9141152-01	9141152-01	9141152-01	Condenser
16	9091086-03		9091086-03	9091086-03	9091086-03	Service Valve Cap
17	9091086-02		9091086-02	9091086-02	9091086-02	Service Valve Core
18	9091086-01		9091086-01	9091086-01	9091086-01	Service Valve Stem
	<b>CIM0335A</b>		<b>CIM0435A</b>	<b>CIM0535A</b>	<b>CIM0635A</b>	<b>Starting Components</b>
	<b>9181165-101</b>		<b>9181138-11A</b>	9181166-11	<b>9181147-11</b>	Compressor Kit
	<b>9181003-54</b>		<b>9181003-32</b>	9181003-32	<b>9181003-54</b>	Start Capacitor
	<b>9181009-26</b>		<b>9181009-26</b>	9181009-28	<b>9181009-17</b>	Run Capacitor
	<b>9181010-27</b>		<b>9181010-32</b>	9181010-34	<b>9181010-01</b>	Compressor Relay
	<b>9181005-50</b>		<b>9181005-46</b>	9181005-51	<b>Internal</b>	Overload

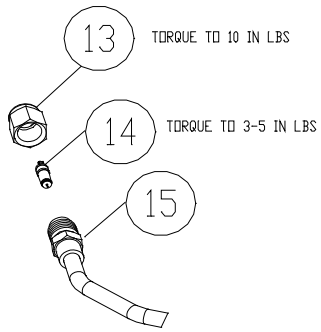

SWITCH, HIGH PRESSURE

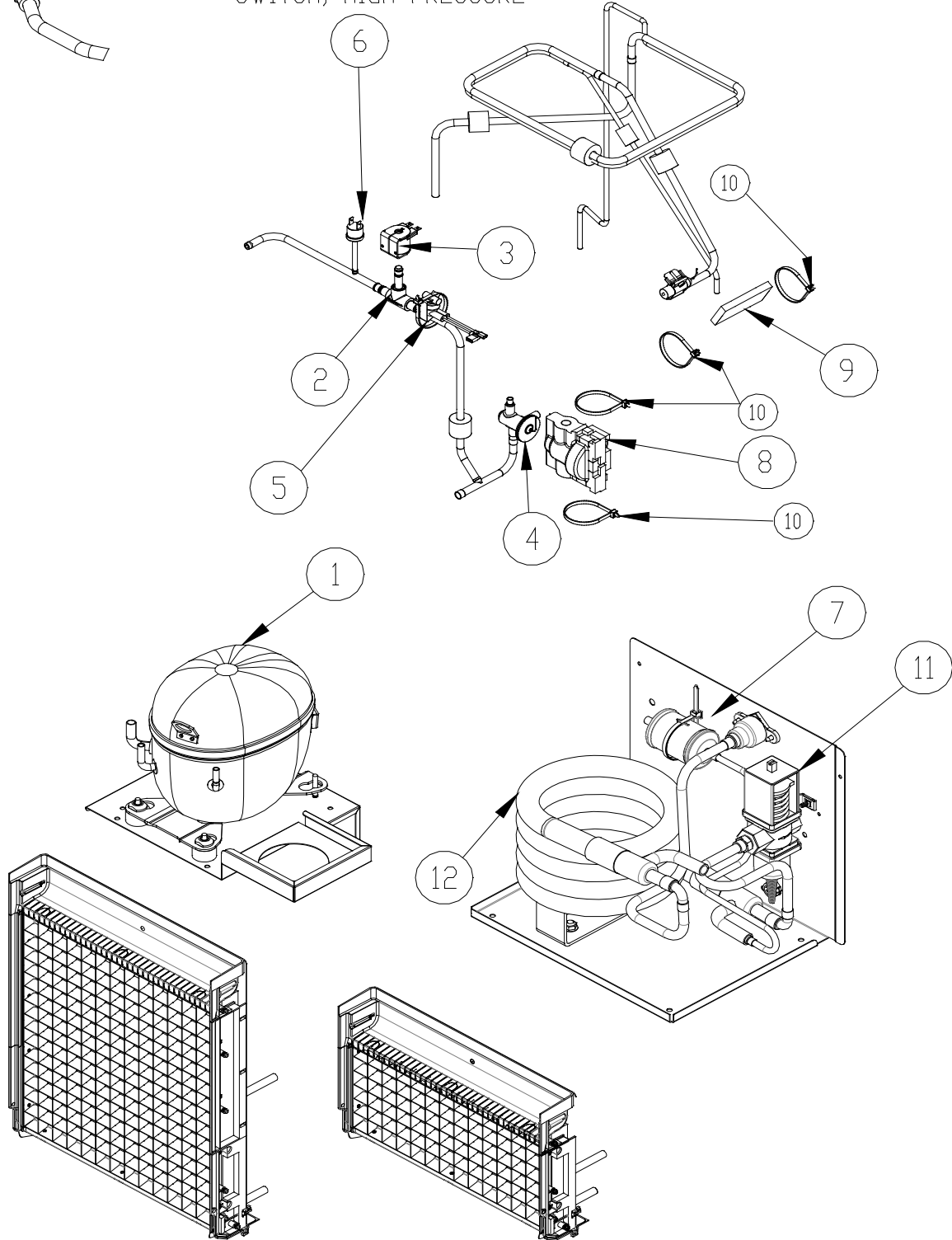

REFERENCE PAGE 4 AND 5 FOR EVAPORATOR

Item No.	Model Number					Description
	CIM0330W	CIM0430W	CIM0436W	CIM0530W	CIM0636W	
1	9181163-101	9181163-101	9181164-101	9181137-11B	9181145-11A	Compressor <b>See Below For Starting Components</b>
2	9151192-03	9151192-03	9151192-03	9151192-03	9151192-03	Hot Gas Valve Body
3	9151193-01	9151193-01	9151193-02	9151193-01	9151193-02	Hot Gas Valve Coil
4	9151154-01	9151149-01	9151149-01	9151149-01	9151149-01	TXV
5	9041098-02	9041098-02	9041098-02	9041098-02	9041098-02	High Temp Switch
6	9041111-01	9041111-01	9041111-01	9041111-01	9041111-01	Switch, High Pressure
7	9151163-01	9151163-01	9151163-01	9151163-01	9151163-01	Drier
8	9131544-01	9131544-01	9131544-01	9131544-01	9131544-01	Insulation, TXV
9	9131143-07	9131143-07	9131143-07	9131143-07	9131143-07	Insulation, Bulb
10	9021021-01	9021021-01	9021021-01	9021021-01	9021021-01	Cable Tie-For TXV and Bulb Insulation
11	9051104-01	9051104-01	9051104-01	9051104-01	9051104-01	Water Regulator
12	9141156-01	9141156-01	9141156-01	9141156-01	9141156-01	Condenser
13	9091086-03	9091086-03	9091086-03	9091086-03	9091086-03	Service Valve Cap
14	9091086-02	9091086-02	9091086-02	9091086-02	9091086-02	Service Valve Core
15	9091086-01	9091086-01	9091086-01	9091086-01	9091086-01	Service Valve Stem
	115/60/1	115/60/1	208-230/60/1	115/60/1	208-230/60/1	Machine Voltage
	CIM0330A	CIM0430A	CIM0436A	CIM0530A	CIM0636A	Starting Components
	9181163-101	9181163-101	9181164-101	9181137-11B	9181145-11A	Compressor Kit
	9181003-50	9181003-50	9181003-26	9181003-50	9181003-52	Start Capacitor
	9181009-25	9181009-25	9181009-08	9181009-25	9181009-19	Run Capacitor
	9181010-33	9181010-33	9181010-27	9181010-14	9181010-27	Compressor Relay
	9181005-49	9181005-49	9181005-50	9181005-45	Internal	Overload

Item No.	Model Number 220-240/50/1					Description
				CIM0535W	CIM0635W	
1				9181166-11	9181147-11	Compressor <b>See Below For Starting Components</b>
2				9151192-03	9151192-03	Hot Gas Valve Body
3				9151193-02	9151193-02	Hot Gas Valve Coil
4				9151149-01	9151149-01	TXV
5				9041098-02	9041098-02	High Temp Switch
6				9041111-01	9041111-01	Switch, High Pressure
7				9151163-01	9151163-01	Drier
8				9131544-01	9131544-01	Insulation, TXV
9				9131143-07	9131143-07	Insulation, Bulb
10				9021021-01	9021021-01	Cable Tie-For TXV and Bulb Insulation
11				9051104-01	9051104-01	Water Regulator
12				9141156-01	9141156-01	Condenser
13				9091086-03	9091086-03	Service Valve Cap
14				9091086-02	9091086-02	Service Valve Core
15				9091086-01	9091086-01	Service Valve Stem
				CIM0535A	CIM0635A	Starting Components
				9181166-11	9181147-11	Compressor Kit
				9181003-32	9181003-54	Start Capacitor
				9181009-28	9181009-17	Run Capacitor
				9181010-34	9181010-01	Compressor Relay
				9181005-51	Internal	Overload

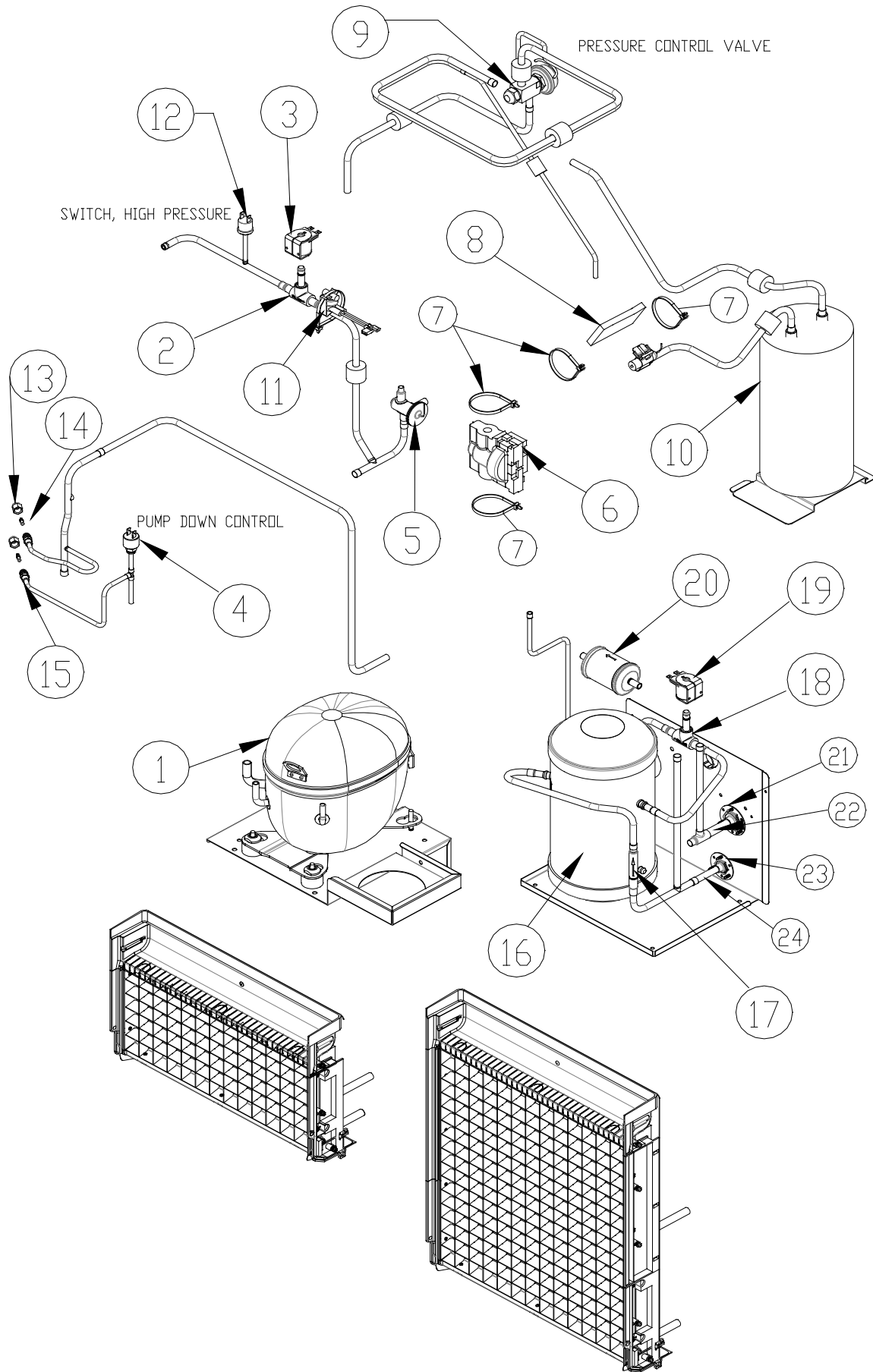

REFERENCE PAGE 4 AND 5 FOR EVAPORATOR

Item No.	Model Number			Description
	CIM0530R	CIM0535R	CIM0636R	
1	9181137-11B	9181166-11	9181145-11A	Compressor <b>See Below For Starting Components</b>
2	9151192-01	9151192-01	9151192-01	Hot Gas Valve Body
3	9151193-01	9151193-02	9151192-02	Hot Gas Valve Coil
4	9041092-02	9041092-02	9041092-02	Pump Down Control
5	9151149-01	9151149-01	9151149-01	TXV
6	9131544-01	9131544-01	9131544-01	Insulation, TXV
7	9021025-01	9021025-01	9021025-01	Cable Tie-For TXV and Bulb Insulation
8	9131143-07	9131143-07	9131143-07	Insulation, TXV Bulb
9	9151146-01	9151146-01	Not Used	Pressure Control Valve
10	9151071-01	9151071-01	Not Used	Accumulator
11	9041098-02	9041098-02	9041098-02	High Temp Switch
12	9041111-01	9041111-01	9041111-01	Switch, High Pressure
13	9091086-03	9091086-03	9091086-03	Service Valve Cap
14	9091086-02	9091086-02	9091086-02	Service Valve Core
15	9091086-01	9091086-01	9091086-01	Service Valve Stem
16	9151074-01	9151074-01	9151074-01	Receiver
17	9151139-01	9151139-01	9151139-01	Check Valve
18	9151192-02	9151192-02	9151192-02	Liquid Line Solenoid
19	9151193-01	9151193-02	9151192-02	Liquid Line Coil
20	9151163-03	9151163-03	9151163-03	Drier
21	9091001-09	9091001-09	9091001-09	1/2 Inch Coupling Flange (Large)
22	9091001-12	9091001-12	9091001-12	1/2 Inch Coupling (Large)
23	9091001-03	9091001-03	9091001-03	3/8 Inch Coupling Flange (Small)
24	9091001-11	9091001-11	9091001-11	3/8 Inch Coupling (Small)
	CIM0530R	CIM0535A	CIM0636R	Starting Components
	9181137-11B	9181166-11	9181145-11A	Compressor Kit
	9181003-50	9181003-32	9181003-52	Start Capacitor
	9181009-25	9181009-28	9181009-19	Run Capacitor
	9181010-14	9181010-34	9181010-27	Potential Relay
	9181005-45	9181005-51	Internal	Overload
	115/60/1	220-240/50/1	208-230/60/1	Machine Voltage

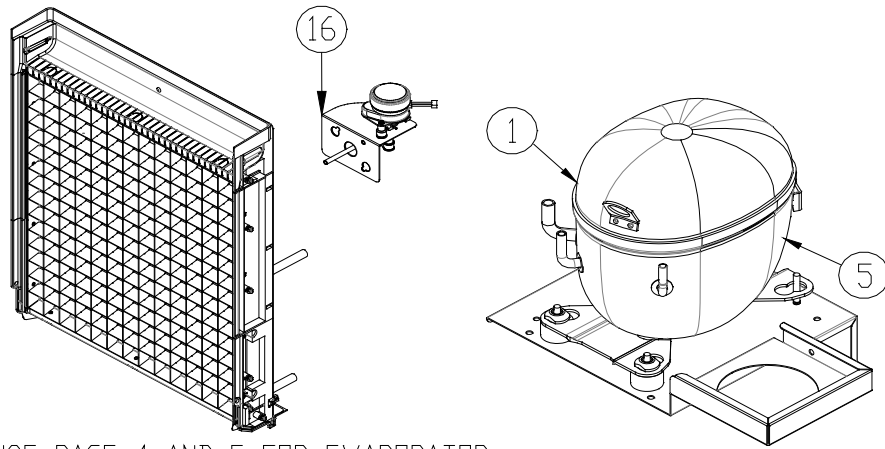

REFERENCE PAGE 4 AND 5 FOR EVAPORATOR

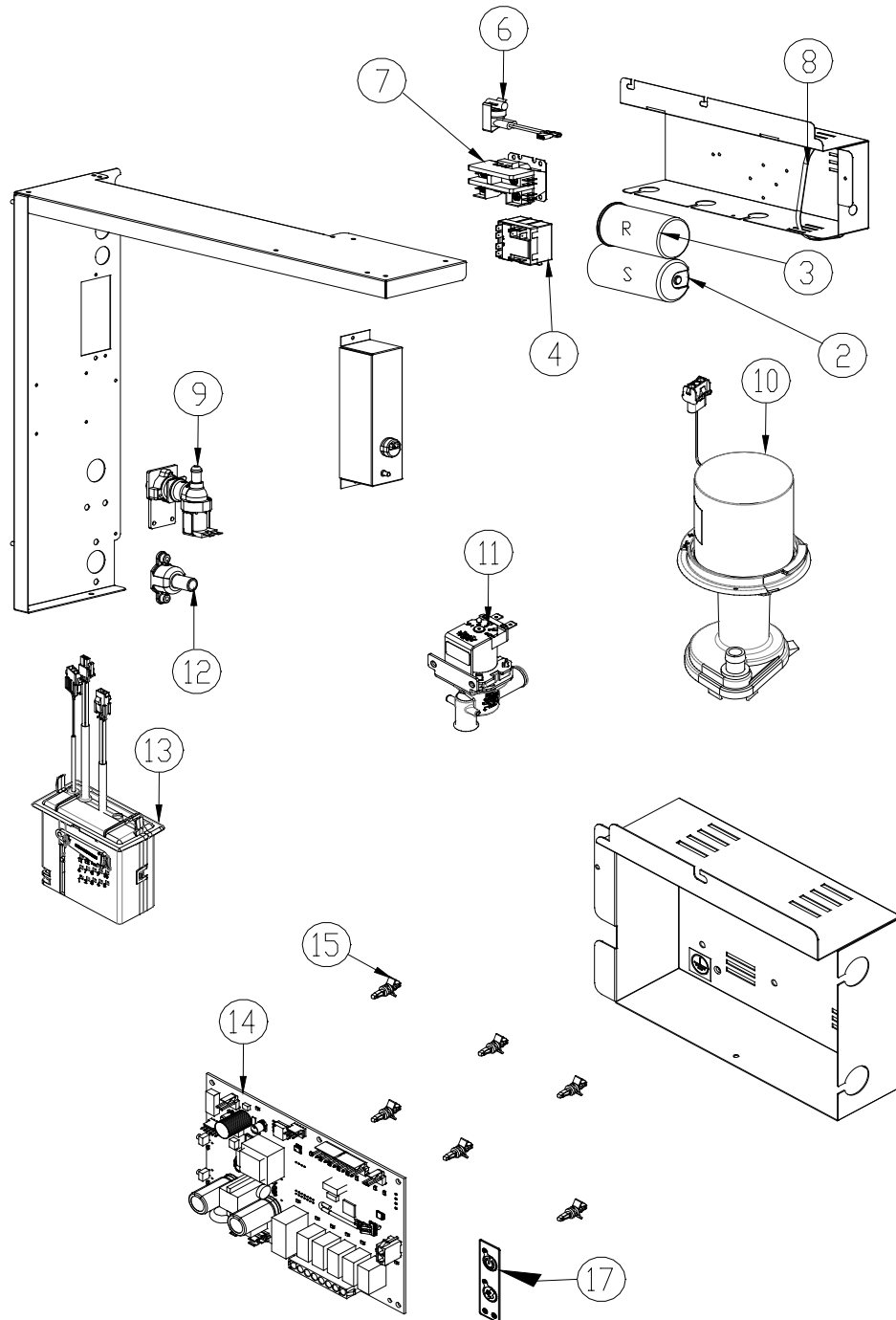

Item No.	Model Number					Description
	CIM0330A	CIM0430A	CIM0436A	CIM0530A	CIM0636A	
1	9181163-101	9181163-101	9181164-101	9181137-11B	9181145-11A	Compressor
2	9181003-50	9181003-50	9181003-26	9181003-50	9181003-52	Start Capacitor
3	9181009-25	9181009-25	9181009-08	9181009-25	9181009-19	Run Capacitor
4	9181010-33	9181010-33	9181010-27	9181010-14	9181010-27	Potential Relay
5	9181005-49	9181005-49	9181005-50	9181005-45	Internal	Overload
6	9041098-02	9041098-02	9041098-02	9041098-02	9041098-02	Switch, High Temp
7	9101002-07	9101002-07	9101002-06	9101002-07	9101002-06	Contactora
8	9021096-01	9021096-01	9021096-01	9021096-01	9021096-01	Cable Tie, Metal
9	9041108-01	9041108-01	9041108-02	9041108-01	9041108-02	Valve, Water Inlet
10	2062336-01	2062336-01	2062336-02	2062336-01	2062336-02	Water Pump
11	9041105-04	9041105-04	9041105-05	9041105-04	9041105-05	Purge Valve
12	9091140-01	9091140-01	9091140-01	9091140-01	9091140-01	Purge Drain
13	1051224-01	1051224-01	1051224-01	1051224-01	1051224-01	Float Switch Assembly (Includes Instructions)
14	9101368-02	9101368-02	9101368-02	9101368-02	9101368-02	Board
15	9051698-01P	9051698-01P	9051698-01P	9051698-01P	9051698-01P	Plastic Standoff, Control Board (Pkg of 10)
16	9161134-01	9161134-01	9161134-02	9161134-01	9161134-02	Harvest Assist
17	9101394-01	9101394-01	9101394-01	9101394-01	9101394-01	Membrane Switch (Includes Cable)
	115/60/1	115/60/1	208-230/60/1	115/60/1	208-230/60/1	Machine Voltage

Item No.	Model Number 220-240/50/1					Description
	CIM0335A		CIM0435A	CIM0535A	CIM0635A	
1	9181165-101		9181138-11A	9181166-11	9181147-11	Compressor Kit
2	9181003-54		9181003-32	9181003-32	9181003-54	Start Capacitor
3	9181009-26		9181009-26	9181009-28	9181009-17	Run Capacitor
4	9181010-27		9181010-32	9181010-34	9181010-01	Compressor Relay
5	9181005-50		9181005-46	9181005-51	Internal	Overload
6	9041098-02		9041098-02	9041098-02	9041098-02	Switch, High Temp
7	9101002-06		9101002-06	9101002-06	9101002-06	Contactora
8	9021096-01		9021096-01	9021096-01	9021096-01	Cable Tie, Metal
9	9041108-02		9041108-02	9041108-02	9041108-02	Valve, Water Inlet
10	2062336-02		2062336-02	2062336-02	2062336-02	Water Pump
11	9041105-05		9041105-05	9041105-05	9041105-05	Purge Valve