

FD-650M_H-C

MODULAR CUBELET ICE MACHINE

SLIM-LINE DISPENSER SERIES

Item # _____

Project: _____

Qty: _____

*AutoCad available on KCL

FD-650M_H-C

6/14

Item # 13327

CUBELET DIMENSIONS

W x D x H

FD-650M_H-C
22 x 24 x 26



FD-650MAH-C

Air-Cooled

Shown on an optional
Lancer 30" Dispenser

FD-650MWH-C

Water-Cooled

FD-650MRH-C

Remote Air-Cooled

- Up to 650 lbs. of ice production per 24 hours
- Durable stainless steel exterior
- Advanced CleanCycle24® Design
- Produces ideal chewable cubelet ice
- Dispenser ready / infrared bin control



- Protected by H-GUARD Plus Antimicrobial Agent



* The FD-650MAH and FD-650MRH are ENERGY STAR qualified.



ISO9001-15014E01

Warranty

Valid in United States, Canada, Puerto Rico, & U.S. Territories. Contact factory for warranty in other countries.

Three Year - Parts & Labor on entire machine. (Serial numbers VxxxxxJ and after.)

Five Year - Parts on compressor, air-cooled condenser coil.



Hoshizaki

FD-650M_H-C CUBELET ICE MACHINE SLIM-LINE DISPENSER SERIES

DIMENSIONS W x D x H

FD-650M_H-C
22 x 24 x 26

- Air-cooled
- Water-cooled
- Remote Air-cooled

AIR-COOLED

Water Temp° F.	50°	70°	90°	
Air Temp° F.	70°	650	627	593
80°	576	523	490	
90°	490	474	439	

WATER-COOLED

Water Temp° F.	50°	70°	90°	
Air Temp° F.	70°	615	601	585
80°	569	554	539	
90°	525	532	497	

REMOTE AIR-COOLED

Water Temp° F.	50°	70°	90°	
Air Temp° F.	70°	590	571	551
80°	531	513	495	
90°	477	476	444	

UTILITY CONSUMPTION

Model Number	KWH per 100 LBS. 90/70	Potable Water Gal. per 100 lbs.
FD-650MAH-C	5.35	12.0
FD-650MWH-C	3.81	12.0
FD-650MRH-C	4.75	12.0

SPECIFICATIONS

Model Number	Condenser	Amperage	Min. Circuit Ampacity	Shipping Weight
FD-650MAH-C	Air-Cooled	11.2	20	205 lbs.
FD-650MWH-C	Water-Cooled	7.8	20	205 lbs.
FD-650MRH-C	Remote Air-Cooled	10.8	20	205 lbs.

*CUBELET DIMENSIONS

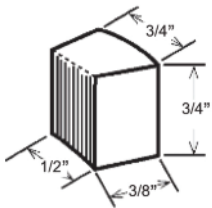

*approximate size in inches, image not to scale

ELECTRICAL & PLUMBING/FD-650M_H-C

- 115V/60/1
- 3/8" OD copper or equivalent independent potable water supply with 1/4" nominal ID minimum
- 3/4" FPT independent drain connection



© HOSHIZAKI AMERICA, INC.

618 Hwy. 74 S., Peachtree City, GA 30269

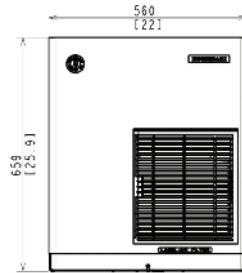

FRONT VIEW

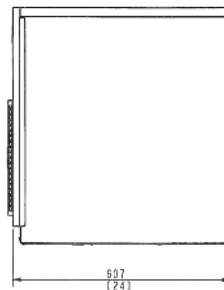

SIDE VIEW

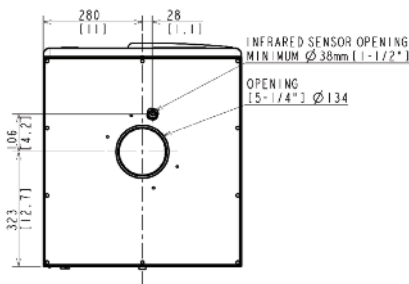

ICE DROP ZONE

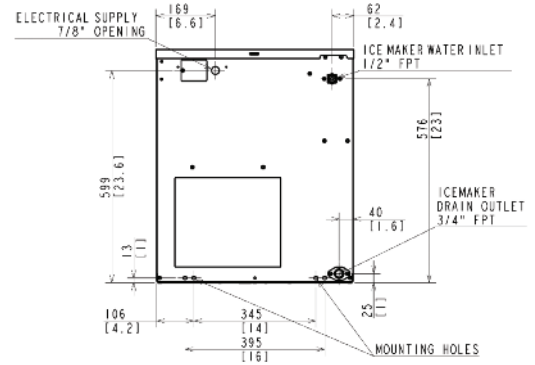

AIR-COOLED UNIT

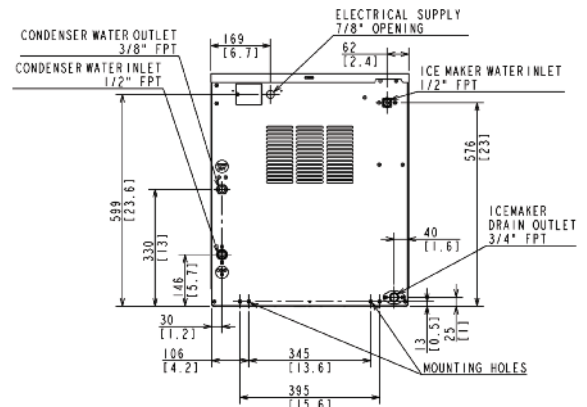

WATER-COOLED UNIT

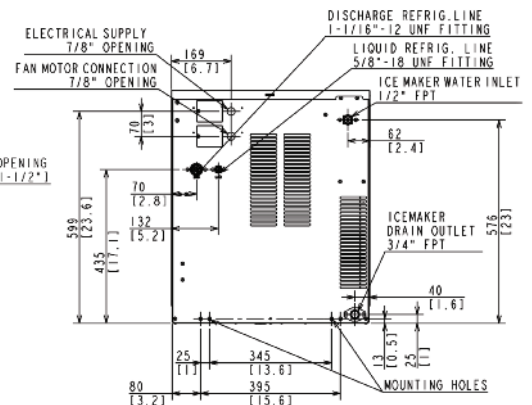

REMOTE AIR-COOLED UNIT

All measurements are mm [in]

OPERATING LIMITS

- Ambient Temp Range 45 - 100°F
- Water Temp Range 45 - 90°F
- Water Pressure 10 - 113psig
- Voltage Range 104 - 127V

SERVICE

- Panels easily removed and all components accessible for service.
- Removable/cleanable air filter. (Air-Cooled model only)

TEL 1-800-438-6087

FAX 1-800-345-1325

www.hoshizaki.com

Printed in U.S.A.

