



# FD-1002M\_J-C

Modular Ice Machine  
Slim-Line Dispenser Series



FD-1002M\_J-C  
03/31/17  
Item # 13242

W x D x H  
22" x 24" x 26"

**FD-1002MAJ-C** ★  
Air-Cooled Flaker  
Shown on optional bin B-700

**FD-1002MRJ-C** ★  
Remote Air-Cooled Cubelet



## Features

- ▶ Durable stainless steel exterior
- ▶ Advanced CleanCycle24™ design 
- ▶ Stainless steel auger with greaseless bearing

- Up to 890 lbs. of ice production per 24 hours
- 2 second flush cycle every hour
- Flush cycle removes sediment for cleaner ice
- Infrared bin control for easy cleaning and reliability
- Protected by H-GUARD Plus Antimicrobial Agent 
- Ice on beverage design
- Popular cubelet ice
- R-404A Refrigerant

### Available on Bins:

**B-250PF B-500PF/SF B-700PF/SF B-800PF/SF B-900PF/SF**  
Top kit may be required; See Bin Spec Sheets.

### Warranty:

3 Year Parts & Labor on entire machine. 5 Year Parts on Compressor; air-cooled condenser coil. Valid in United States, Canada, Puerto Rico and U.S. Territories. Contact factory for warranty in other countries.

Condenser	Model	ICE PRODUCTION		Type of Ice (Hardness Rating)	WATER USAGE		ELECTRICAL			Heat Rejection BTU/hr.	Shipping Weight	ENERGY STAR®	
		Air / Water Temp Lbs. per 24 hours 70°/ 50°F	90°/ 70°F		Potable Gal. per 100 lbs. 90°/ 70°F	Condenser Gal. per 100 lbs. 90°/ 70°F	kWh Used per 100 lbs. 90°/ 70°F	Max. Fuse Size or HACR Circuit Breaker	Amperage				Voltage
Air-Cooled	FD-1002MAJ-C	890	726	Cubelet (87.1)	12.0	N/A	4.57	20A	15.2A	115V/60/1	8,700	210 lbs.	★
Remote Air-Cooled	FD-1002MRJ-C	821	680	Cubelet (85.9)	12.0	N/A	4.94	20A	13.7A	115V/60/1	8,500	210 lbs.	★

### Cube Dimensions\*

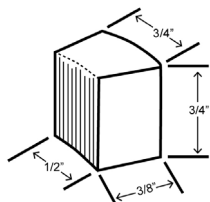

\* approximate size in inches, image not to scale

### Operating Limits

- Ambient Temp Range 45 - 100°F
- Water Temp Range 45 - 90°F
- Water Pressure 10 - 113 PSIG
- Voltage Range 104-127V

### Service

- Panels easily removed and all components accessible for service.
- Allow 24" (61 cm) clearance at top for removal of auger and 6" (15 cm) clearance at rear and sides for proper air circulation and ease of maintenance/service.

### Plumbing

- Icemaker Water Supply Line: Minimum 1/4" Nominal ID Copper Water Tubing or Equivalent
- Icemaker Drain Line: Minimum 3/4" Nominal ID Hard Pipe or Equivalent



# FD-1002M\_J-C

## Modular Ice Machine Slim-Line Dispenser Series



FD-1002M\_J-C  
03/31/17  
Item # 13242

FRONT VIEW

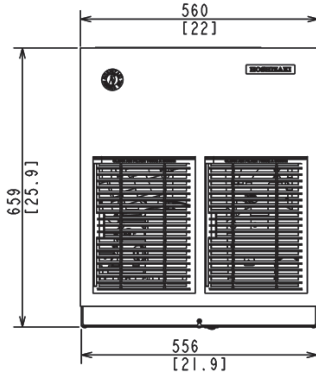

AIR-COOLED

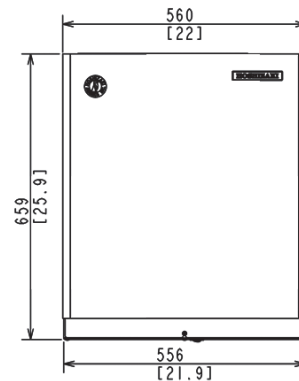

REMOTE AIR-COOLED

mm  
[inch]

SIDE VIEW

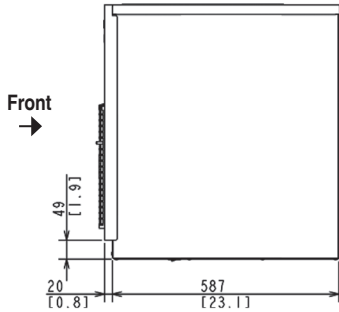

AIR-COOLED

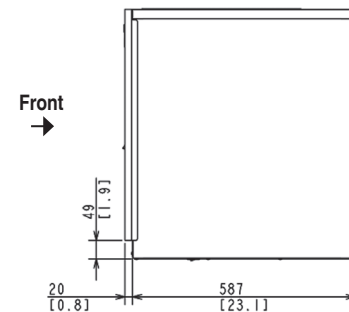

REMOTE AIR-COOLED

REAR VIEW

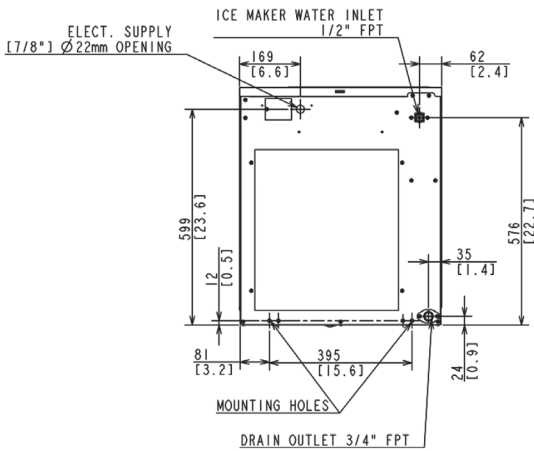

AIR-COOLED

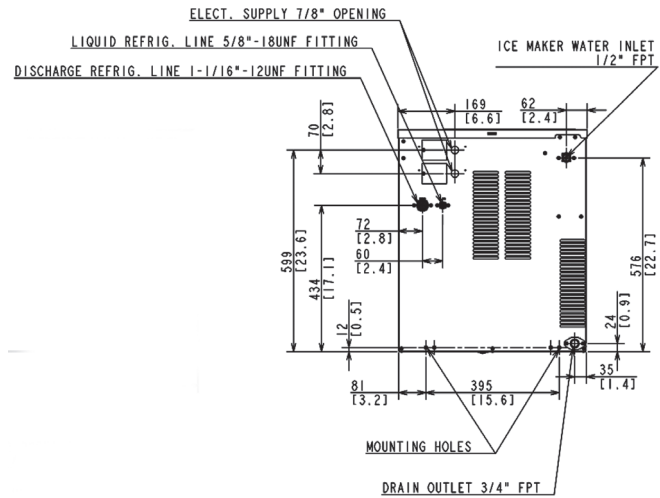

REMOTE AIR-COOLED

BOTTOM VIEW

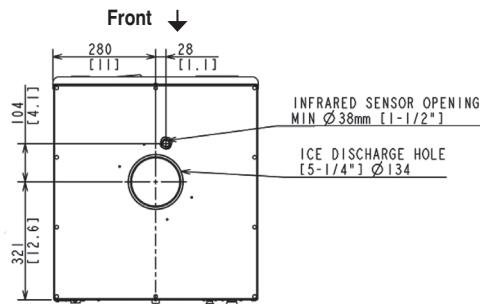

AIR-COOLED  
REMOTE AIR-COOLED

URC-5F Remote Condenser (Sold Separately)  
(W x D x H) 21 13/16 x 14 1/16 x 32 13/16  
For Use with FD-1002MRJ(-C)



Pre-Charged Tubing Kits  
(Sold Separately)  
20' R404-2046-2  
35' R404-3546-2

Voltage supply for the URC  
Remote Condenser is supplied  
from the Ice Maker.  
No additional circuit is required.

