



SERVICE PARTS MANUAL GEM-MFI SERIES



14-1035

Date 9/21/17

This parts list contains the service parts available for the GEM-MFI Series icemakers listed below:

From Serial Number 10021280010227

GEM0450 Air Cooled-Water Cooled

GEM0650 Air Cooled-Water Cooled-Remote, Includes 50 hz.

GEM0956-Air Cooled-Water Cooled-Remote, Includes 50 hz.

MFI0500 Air Cooled-Water Cooled

MFI0800 Air Cooled-Water Cooled-Remote, Includes 50 hz.

MFI1256 Air Cooled-Water Cooled-Remote, Includes 50hz.

Check the model number on the data plate and refer to the correct listing for the specific component.

Check carefully that the correct part is identified and ordered.

Table of Contents	Page 1
Cabinet Assembly	Page 2 - 3
Air Cooled	Page 4 - 5
Water Cooled	Page 6 - 7
Remote	Page 8 - 9
Down Chute/Water System	Page 10 - 11
Control Box	Page 12
Gearmotor	Page 13
Evaporator	Page 14 - 15
Remote Condenser	Page 16
Compressor and Components	Page 17

Ice-O-Matic
11100 East 45th Ave.
Denver Co. 80239
800-423-3367

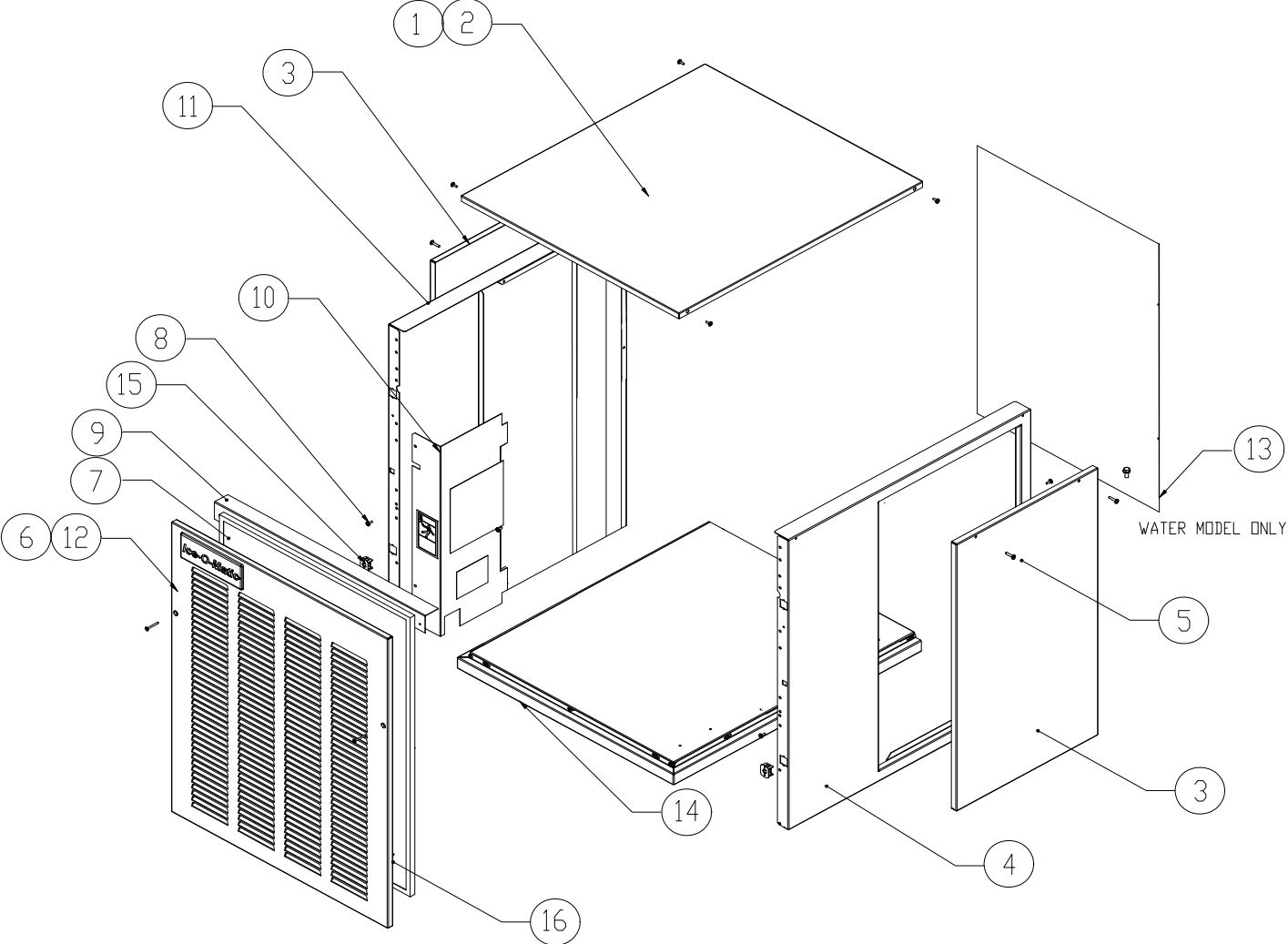

Item No.	Model Number						Description
	GEM0450	GEM0650	GEM0956	MFI0500	MFI0800	MFI1256	
1	3021951-01	3021951-01	3021951-01	3021951-01	3021951-01	3021951-01	Panel, Top
2	9031046-27	9031046-27	9031046-27	9031046-27	9031046-27	9031046-27	Screw
3	3021953-01	3021953-01	3021953-01	3021953-01	3021953-01	3021953-01	Panel, Service
4	3021952-01	3021952-01	3021952-01	3021952-01	3021952-01	3021952-01	Panel, End, Right
5	9031113-14	9031113-14	9031113-14	9031113-14	9031113-14	9031113-14	Screw
6	2031515-01	2031515-01	2031515-01	2031515-01	2031515-01	2031515-01	Front Panel-Louvered
	2031519-01	2031519-01	2031519-01	2031519-01	2031519-01	2031519-01	Solid Front Panel-No Louvers
7	9131475-01	9131475-01	9131475-01	9131475-01	9131475-01	9131475-01	Air Filter
8	9031046-03	9031046-03	9031046-03	9031046-03	9031046-03	9031046-03	Screw (Replaces 9131046-27)
9	2021701-01	2021701-01	2021701-01	2021701-01	2021701-01	2021701-01	Front Brace
10	3013391-01	3013391-01	3013391-01	3013391-01	3013391-01	3013391-01	Control Box Cover
11	3021950-01	3021950-01	3021950-01	3021950-01	3021950-01	3021950-01	Panel, End, Left
12	9031045-07	9031045-07	9031045-07	9031045-07	9031045-07	9031045-07	Screw
13	3013392-01	3013392-01	3013392-01	3013392-01	3013392-01	3013392-01	Panel, Rear
14	2021699-01	2021699-01	2021699-01	2021699-01	2021699-01	2021699-01	Base
15	9021112-01	9021112-01	9021112-01	9021112-01	9021112-01	9021112-01	Cabinet Catch
16	9021121-01	9021121-01	9021121-01	9021121-01	9021121-01	9021121-01	Strike

Item No.	Model Number						Description
		GEM0655	GEM0955		MFI0805	MFI1255	
1		3021951-01	3021951-01		3021951-01	3021951-01	Panel, Top
2		9031046-27	9031046-27		9031046-27	9031046-27	Screw
3		3021953-01	3021953-01		3021953-01	3021953-01	Panel, Service
4		3021952-01	3021952-01		3021952-01	3021952-01	Panel, End, Right
5		9031113-14	9031113-14		9031113-14	9031113-14	Screw
6		2031515-01	2031515-01		2031515-01	2031515-01	Front Panel
		2031519-01	2031519-01		2031519-01	2031519-01	Solid Front Panel-No Louvers
7		9131475-01	9131475-01		9131475-01	9131475-01	Air Filter
8		9031046-03	9031046-03		9031046-03	9031046-03	Screw (Replaces 9131046-27)
9		2021701-01	2021701-01		2021701-01	2021701-01	Front Brace
10		3013391-01	3013391-01		3013391-01	3013391-01	Control Box Cover
11		3021950-01	3021950-01		3021950-01	3021950-01	Panel, End, Left
12		9031045-07	9031045-07		9031045-07	9031045-07	Screw
13		3013392-01	3013392-01		3013392-01	3013392-01	Panel, Rear
14		2021699-01	2021699-01		2021699-01	2021699-01	Base
15		9021112-01	9021112-01		9021112-01	9021112-01	Cabinet Catch
16		9021121-01	9021121-01		9021121-01	9021121-01	Front Panel Catch

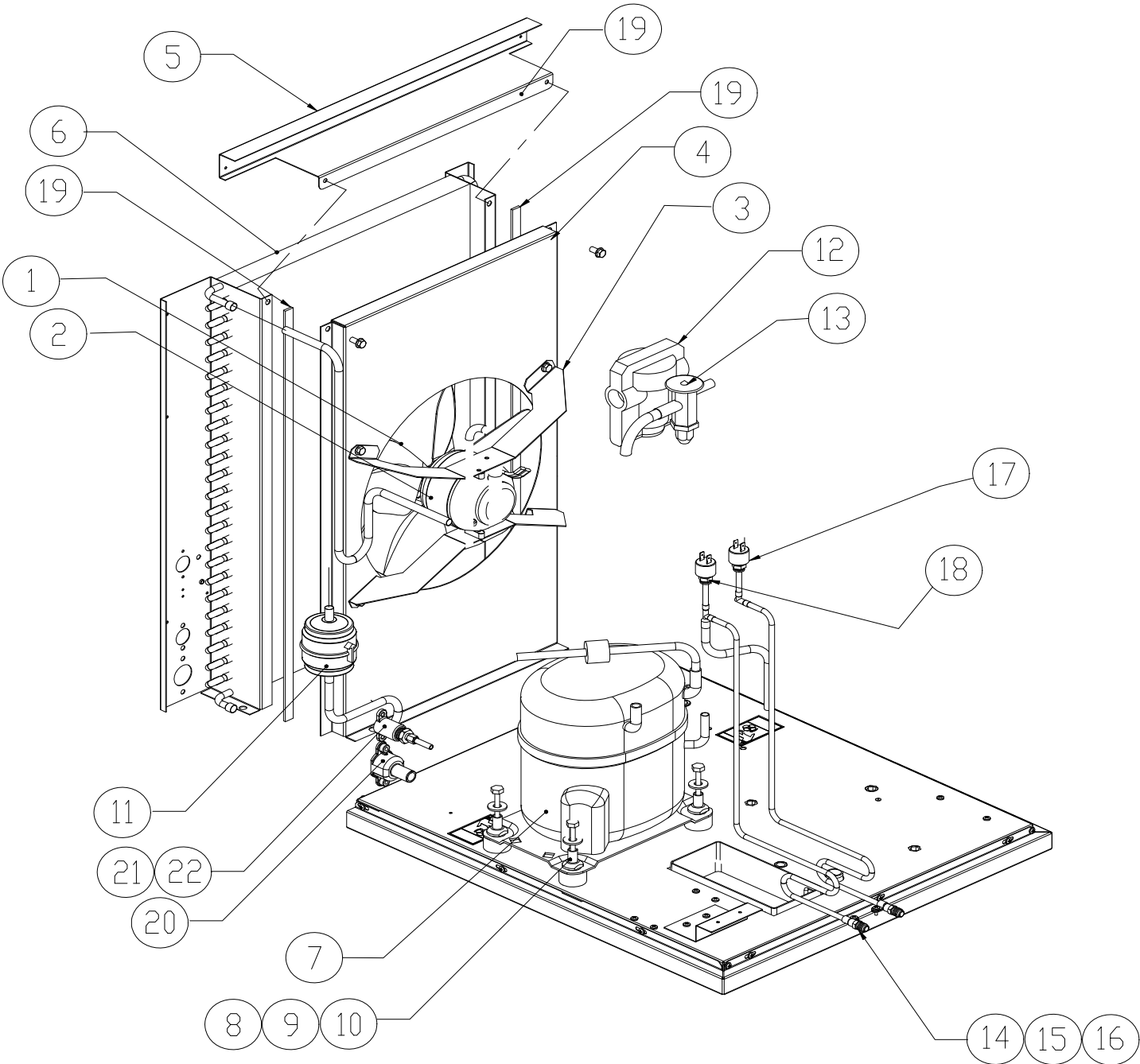

GEM-MFI Series Service Parts

Air Cooled

Item No.	Model Number						Description
	GEM0450	GEM0650	GEM0956	MFI0500	MFI0800	MFI1256	
1	9131489-01	9131489-01	9131487-01	9131489-01	9131489-01	9131487-01	Fan Blade
2			9161120-02			9161120-02	Fan Motor
	9161124-01	9161124-01		9161124-01	9161124-01		Fan Motor, 9161078-01 is NLA
3	3013394-01	3013394-01	3013393-01	3013394-01	3013394-01	3013393-01	Fan Bracket
4	3013379-01	3013379-01	3013372-01	3013379-01	3013379-01	3013372-01	Fan Shroud
5	3013378-01	3013378-01	3013378-01	3013378-01	3013378-01	3013378-01	Fan Shroud Cover
6	9141139-01	9141139-01	9141138-01	9141139-01	9141139-01	9141138-01	Air Condenser
7	9181131-11	1051175-01	1051187-01	9181131-11	1051175-01	1051187-01	Compressor
		9181137-11	9181145-11		9181137-11	9181145-11	Compressor-See Note Below*
8	9031001-41	9031001-41	9031001-41	9031001-41	9031001-41	9031001-41	Compressor Bolt
9	9181002-09	9181002-09	9181002-09	9181002-09	9181002-09	9181002-09	Compressor Grommet
10	9181002-02	9181002-02	9181002-02	9181002-02	9181002-02	9181002-02	Compressor Grommet Sleeve
11	9151163-03	9151163-03	9151163-03	9151163-03	9151163-03	9151163-03	Drier (Replaces 9151004-04)
12	9131143-02	9131143-02	9131143-02	9131143-02	9131143-02	9131143-02	Expansion Valve Insulation
13	9151161-02	9151161-01	9151161-01	9151161-02	9151161-01	9151161-01	Expansion Valve
14	9091086-01	9091086-01	9091086-01	9091086-01	9091086-01	9091086-01	Service Valve Body
15	9091086-02	9091086-02	9091086-02	9091086-02	9091086-02	9091086-02	Service Valve Core
16	9091086-03	9091086-03	9091086-03	9091086-03	9091086-03	9091086-03	Service Valve Cap
17	9041091-01	9041091-01	9041091-01	9041091-01	9041091-01	9041091-01	Hi Pressure Cut Out
18	9041102-01	9041102-01	9041102-01	9041102-01	9041102-01	9041102-01	Low Pressure Cut Out
19	6081004-07	6081004-07	6081004-07	6081004-07	6081004-07	6081004-07	Gasket Strip, Flat 4 Ft. Required
20	9091140-01	9091140-01	9091140-01	9091140-01	9091140-01	9091140-01	Drain Fitting
21	9091074-01	9091074-01	9091074-01	9091074-01	9091074-01	9091074-01	Drop Adapter
22	9091083-01	9091083-01	9091083-01	9091083-01	9091083-01	9091083-01	Water Inlet Fitting

*Note GEM0650/MFI0800 Version 3, beginning with serial number 11061280013385

*Note GEM0956 Version 3, beginning with serial number 12021280011342

*Note MFI1256 Version 3, beginning with serial number 12021280011175

Item No.	Model Number						Description
		GEM0655	GEM0955		MFI0805	MFI1255	
1		9131489-01	9131487-01		9131489-01	9131487-01	Fan Blade
2			9161120-02			9161120-02	Fan Motor
		9161124-02			9161124-02		Fan Motor, 9161078-02 is NLA
3		3013394-01	3013393-01		3013394-01	3013393-01	Fan Bracket
4		3013379-01	3013372-01		3013379-01	3013372-01	Fan Shroud
5		3013378-01	3013378-01		3013378-01	3013378-01	Fan Shroud Cover
6		9141139-01	9141138-01		9141139-01	9141138-01	Air Condenser
7		1051176-01	1051188-01		1051176-01	1051088-01	Compressor
		9181138-11	9181147-11		9181138-11	9181147-11	Compressor-See Note Below*
8		9031001-41	9031001-41		9031001-41	9031001-41	Compressor Bolt
9		9181002-09	9181002-09		9181002-09	9181002-09	Compressor Grommet
10		9181002-02	9181002-02		9181002-02	9181002-02	Compressor Grommet Sleeve
11		9151163-03	9151163-03		9151163-03	9151163-03	Drier (Replaces 9151004-04)
12		9131143-02	9131143-02		9131143-02	9131143-02	Expansion Valve Insulation
13		9151161-01	9151161-01		9151161-01	9151161-01	Expansion Valve
14		9091086-01	9091086-01		9091086-01	9091086-01	Service Valve Body
15		9091086-02	9091086-02		9091086-02	9091086-02	Service Valve Core
16		9091086-03	9091086-03		9091086-03	9091086-03	Service Valve Cap
17		9041091-01	9041091-01		9041091-01	9041091-01	Hi Pressure Cut Out
17A		9041111-01	9041111-01		9041111-01	9041111-01	Hi Pressure Cut Out (Rev 4)
18		9041102-01	9041102-01		9041102-01	9041102-01	Low Pressure Cut Out
19		6081004-07	6081004-07		6081004-07	6081004-07	Gasket Strip, Flat 4 Ft. Required
20		9091140-01	9091140-01		9091140-01	9091140-01	Drain Fitting
21		9091074-01	9091074-01		9091074-01	9091074-01	Drop Adapter
22		9091083-01	9091083-01		9091083-01	9091083-01	Water Inlet Fitting

*Note GEM0655 Version 3, beginning with serial number 1111280010222

*Note MFI1255 Version 3, beginning with serial number 12021280010735

*Note MFI0805 Version 3, beginning with serial number 11071280013262

Note: New High Pressure Cut Out beginning Rev 4

*Note GEM0955 Version 3, beginning with serial number 12021280012562

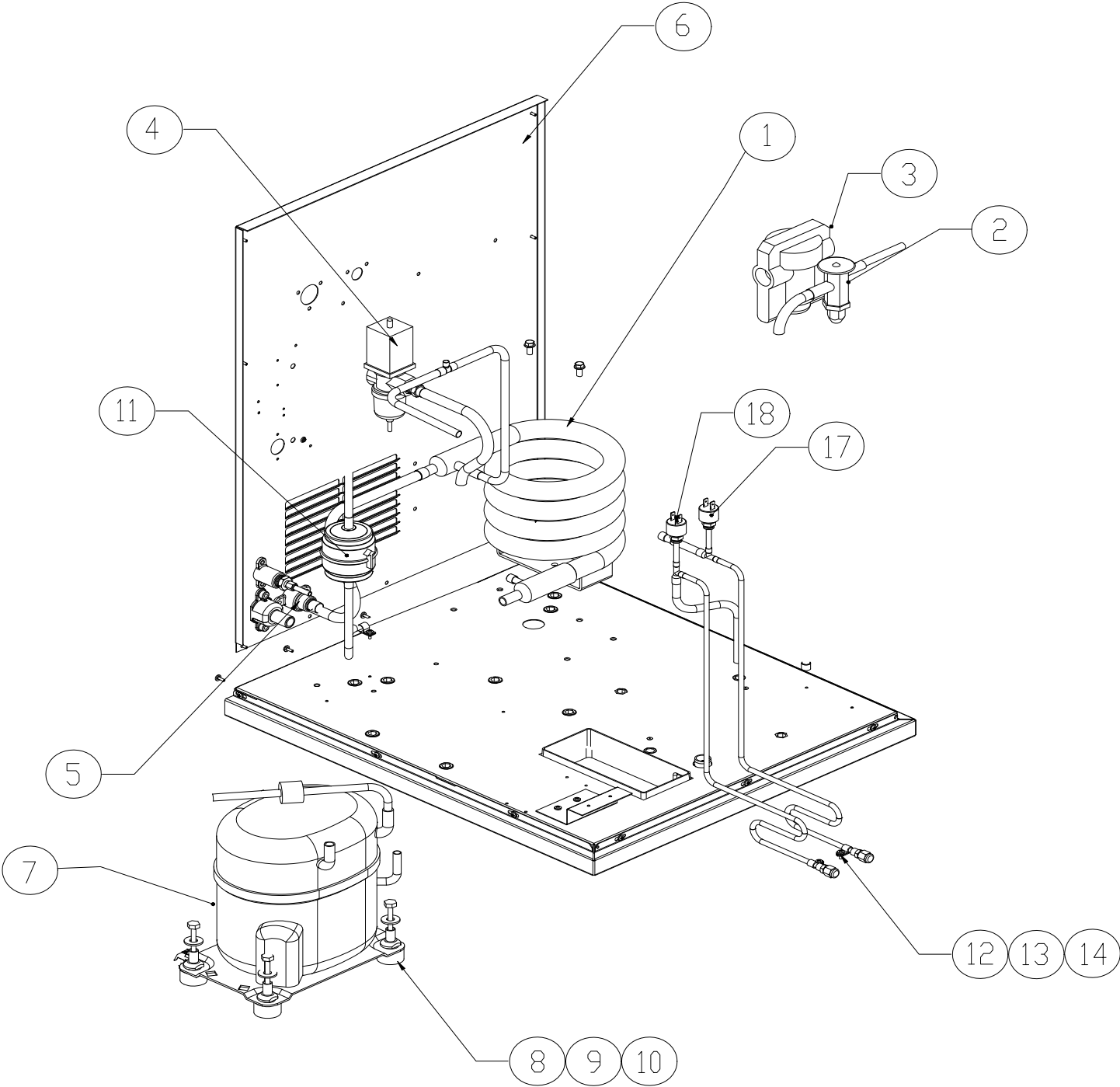

GEM-MFI Series Service Parts

Water Cooled

Item No.	Model Number						Description
	GEM0450	GEM0650	GEM0956	MFI0500	MFI0800	MFI1256	
1	9141141-01	9141141-01	9141142-01	9141141-01	9141141-01	9141142-01	Water Cooled Condenser
2	9151161-02	9151161-01	9151161-01	9151161-02	9151161-01	9151161-01	Expansion Valve
3	9131143-02	9131143-02	9131143-02	9131143-02	9131143-02	9131143-02	Expansion Valve Insulation Kit
4	9041101-01	9041101-01	9041101-01	9041101-01	9041101-01	9041101-01	Water Regulating Valve
5	9091063-02	9091063-02	9091063-02	9091063-02	9091063-02	9091063-02	Water Cooled Condenser Drain
6	3013392-01	3013392-01	3013392-01	3013392-01	3013392-01	3013392-01	Rear Panel
7	9181131-11	1051175-01	1051187-01	9181131-11	1051175-01	1051187-01	Compressor
		9181137-11	9181145-11		9181137-11	9181145-11	Compressor-See Note Below*
8	9031001-41	9031001-41	9031001-41	9031001-41	9031001-41	9031001-41	Compressor Bolt
9	9181002-09	9181002-09	9181002-09	9181002-09	9181002-09	9181002-09	Compressor Grommet
10	9181002-02	9181002-02	9181002-02	9181002-02	9181002-02	9181002-02	Compressor Grommet Sleeve
11	9151163-03	9151163-03	9151163-03	9151163-03	9151163-03	9151163-03	Drier (Replaces 9151004-04)
12	9091086-01	9091086-01	9091086-01	9091086-01	9091086-01	9091086-01	Service Valve Body
13	9091086-02	9091086-02	9091086-02	9091086-02	9091086-02	9091086-02	Service Valve Core
14	9091086-03	9091086-03	9091086-03	9091086-03	9091086-03	9091086-03	Service Valve Cap
15	9041091-01	9041091-01	9041091-01	9041091-01	9041091-01	9041091-01	Hi Pressure Cut Out
16	9041102-01	9041102-01	9041102-01	9041102-01	9041102-01	9041102-01	Low Pressure Cut Out

*Note GEM0650/MFI0800 Version 3, beginning with serial number 11061280013385

*Note GEM0956 Version 3, beginning with serial number 12021280011342

*Note MFI1256 Version 3, beginning with serial number 12021280011175

Item No.	Model Number						Description
		GEM0655	GEM0955		MFI0805	MFI1255	
1		9141141-01	9141142-01		9141141-01	9141142-01	Water Cooled Condenser
2		9151161-01	9151161-01		9151161-01	9151161-01	Expansion Valve
3		9131143-02	9131143-02		9131143-02	9131143-02	Expansion Valve Insulation Kit
4		9041101-01	9041101-01		9041101-01	9041101-01	Water Regulating Valve
5		9091063-02	9091063-02		9091063-02	9091063-02	Water Cooled Condenser Drain
6		3013392-01	3013392-01		3013392-01	3013392-01	Rear Panel
7		1051176-01	1051188-01		1051176-01	1051188-01	Compressor
		9181138-11	9181147-11		9181138-11	9181147-11	Compressor-See Note Below*
8		9031001-41	9031001-41		9031001-41	9031001-41	Compressor Bolt
9		9181002-09	9181002-09		9181002-09	9181002-09	Compressor Grommet
10		9181002-02	9181002-02		9181002-02	9181002-02	Compressor Grommet Sleeve
11		9151163-03	9151163-03		9151163-03	9151163-03	Drier (Replaces 9151004-04)
12		9091086-01	9091086-01		9091086-01	9091086-01	Service Valve Body
13		9091086-02	9091086-02		9091086-02	9091086-02	Service Valve Core
14		9091086-03	9091086-03		9091086-03	9091086-03	Service Valve Cap
15		9041091-01	9041091-01		9041091-01	9041091-01	Hi Pressure Cut Out
15A		9041111-01	9041111-01		9041111-01	9041111-01	Hi Pressure Cut Out (Rev 4)
16		9041102-01	9041102-01		9041102-01	9041102-01	Low Pressure Cut Out

*Note GEM0655 Version 3, beginning with serial number 1111280010222

*Note MFI0805 Version 3, beginning with serial number 11071280013262

*Note GEM0955 Version 3, beginning with serial number 12021280012562

*Note MFI1255 Version 3, beginning with serial number 12021280010735

Note: New High Pressure Cut Out beginning Rev 4

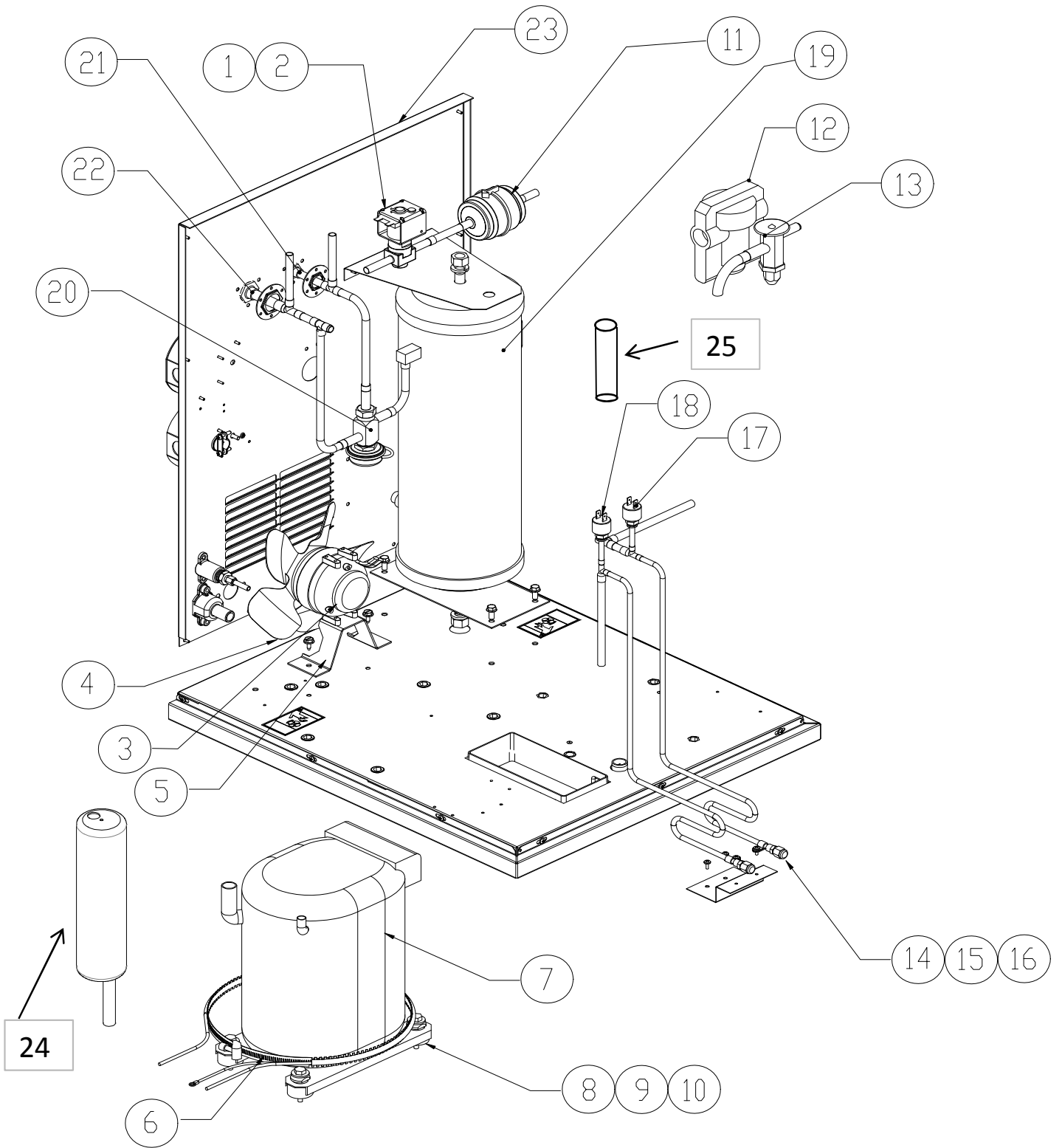

Item No.	Model Number					Description
	GEM0650	GEM0956		MFI0800	MFI1256	
1	9151123-01	9151123-01		9151123-01	9151123-01	Liquid Line Solenoid Body
2	9151123-03	9151123-04		9151123-03	9151123-04	Liquid Line Solenoid Coil
3	9161120-01	9161120-02		9161120-01	9161120-02	Fan Motor
4	9131488-01	9131488-01		9131488-01	9131488-01	Fan Blade
5	3013377-01	3013377-01		3013377-01	3013377-01	Fan Motor Bracket
6	9181132-02	9181132-01		9181132-02	9181132-01	Compressor Crankcase Heater
7	1051175-01	1051187-01		1051175-01	1051187-01	Compressor
	9181137-11	9181145-11		9181137-11	9181145-11	Compressor-See Note Below*
8	9031001-41	9031001-41		9031001-41	9031001-41	Compressor Bolt
9	9181002-09	9181002-09		9181002-09	9181002-09	Compressor Grommet
10	9181002-02	9181002-02		9181002-02	9181002-02	Compressor Grommet Sleeve
11	9151163-03	9151163-03		9151163-03	9151163-03	Drier (Replaces 9151004-04)
12	9131143-02	9131143-02		9131143-02	9131143-02	Expansion Valve Insulation
13	9151161-01	9151161-01		9151161-01	9151161-01	Expansion Valve
	9151182-01	9151182-01		9151182-01	9151182-01	Expansion Valve From Rev 5
14	9091086-01	9091086-01		9091086-01	9091086-01	Service Valve Body
15	9091086-02	9091086-02		9091086-02	9091086-02	Service Valve Core
16	9091086-03	9091086-03		9091086-03	9091086-03	Service Valve Cap
17	9041091-01	9041091-01		9041091-01	9041091-01	Hi Pressure Cut Out
18	9041102-01	9041102-01		9041102-01	9041102-01	Low Pressure Cut Out
19	9151159-01	9151159-01		9151159-01	9151159-01	Receiver
20	9151027-05	9151027-05		9151027-05	9151027-05	Head Pressure Control Valve
21	9091001-11	9091001-11		9091001-11	9091001-11	Quick Connect Fitting 3/8
22	9091001-12	9091001-12		9091001-12	9091001-12	Quick Connect Fitting 1/2
23	3013392-01	3013392-01		3013392-01	3013392-01	Rear Panel
24		9151164-01			9151164-01	Accumulator
25	9151194-01	9151194-01	9151194-01	9151194-01	9151194-01	Check Valve- From Rev 5

*Note GEM0650/MFI0800 Version 3, beginning with serial number 11061280013385

*Note GEM0956 Version 3, beginning with serial number 12021280011342

*Note MFI1256 Version 3, beginning with serial number 12021280011175

Note New Expansion Valve beginning Rev 5

Note New Check Valve beginning Rev 5

Note Items 3,4 and 5 are not applicable starting from Rev 5

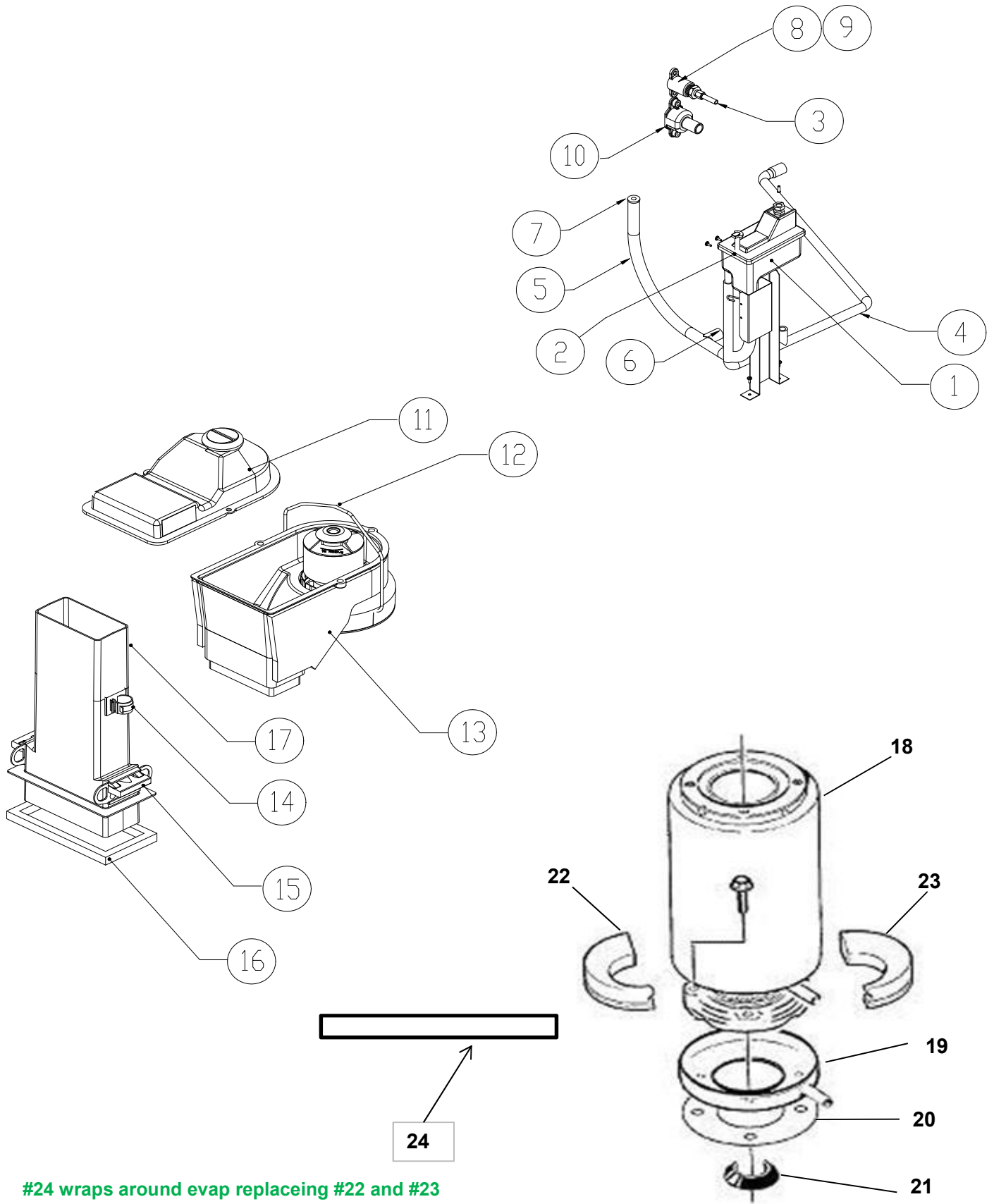

#24 wraps around evap replacing #22 and #23

GEM-MFI Series Service Parts

Down Chute-Water System

Item No.	Model Number						Description
	GEM0450	GEM0650	GEM0956	MFI0500	MFI0800	MFI1256	
1	9131481-01	9131481-01	9131481-01	9131481-01	9131481-01	9131481-01	Float Assembly
2	9101334-01	9101334-01	9101334-01	9101334-01	9101334-01	9101334-01	Probe-Conductivity
3	3032898-40	3032898-40	3032898-40	3032898-40	3032898-40	3032898-40	1/4 OD Polyethylene Tube (40")
4	9051606-02	9051606-02	9051606-01	9051606-02	9051606-02	9051606-01	Tube, Water Drain
5	9051619-01	9051619-01	9051619-01	9051619-01	9051619-01	9051619-01	Tube, Evaporator Water Inlet
6	9021113-01	9021113-01	9021113-01	9021113-01	9021113-01	9021113-01	Clamp
7	9051610-01	9051610-01	9051610-01	9051610-01	9051610-01	9051610-01	Plug
8	9091074-01	9091074-01	9091074-01	9091074-01	9091074-01	9091074-01	Drop Adapter Fitting
9	9091083-01	9091083-01	9091083-01	9091083-01	9091083-01	9091083-01	Water Inlet Fitting
10	9091140-01	9091140-01	9091140-01	9091140-01	9091140-01	9091140-01	Drain Fitting
11	9051602-01	9051602-01	9051602-01	9051602-01	9051602-01	9051602-01	Cover-Ice Chute
12	9131494-01	9131494-01	9131494-01	9131494-01	9131494-01	9131494-01	Clamp-Ice Chute
13	9131495-01	9131495-01	9131495-01	9131495-01	9131495-01	9131495-01	Ice Chute and Foam Assembly
14	9021116-01	9021116-01	9021116-01	9021116-01	9021116-01	9021116-01	Clip-Hose
15	1051166-01	1051166-01	1051166-01	1051166-01	1051166-01	1051166-01	Bin Control Assembly Set of 2
16	9051614-01	9051614-01	9051614-01	9051614-01	9051614-01	9051614-01	Gasket, Ice Chute
17	9051601-01	9051601-01	9051601-02	9051601-01	9051601-01	9051601-02	Ice Chute, Lower
18	9151170-01	9151170-01	9151169-01	9151170-01	9151170-01	9151169-01	Evaporator
19	9051632-01	9051632-01	9051632-01	9051632-01	9051632-01	9051632-01	Drip Pan
20	9131486-01	9131486-01	9131486-01	9131486-01	9131486-01	9131486-01	Drip Pan Gasket
21	9051611-01	9051611-01	9051611-01	9051611-01	9051611-01	9051611-01	Water Shed
22	1011380-178	1011380-178	1011380-178	1011380-178	1011380-178	1011380-178	Insulation NLA Replaced by #24
23	1011380-179	1011380-179	1011380-179	1011380-179	1011380-179	1011380-179	Insulation NLA Replaced by #24
24	9021140-01	9021140-01	9021140-01	9021140-01	9021140-01	9021140-01	Insulation Replaces 22 and 23
25	9131480-01	9131480-01	9131480-01	9131480-01	9131480-01	9131480-01	Nylon Strap

Item No.	Model Number						Description
		GEM0655	GEM0955		MFI0805	MFI1255	
1		9131481-01	9131481-01		9131481-01	9131481-01	Float Assembly
2		9101334-01	9101334-01		9101334-01	9101334-01	Probe-Conductivity
3		3032898-40	3032898-40		3032898-40	3032898-40	1/4 OD Polyethylene Tube (40")
4		9051606-02	9051606-01		9051606-02	9051606-01	Tube, Water Drain
5		9051619-01	9051619-01		9051619-01	9051619-01	Tube, Evaporator Water Inlet
6		9021113-01	9021113-01		9021113-01	9021113-01	Clamp
7		9051610-01	9051610-01		9051610-01	9051610-01	Plug
8		9091074-01	9091074-01		9091074-01	9091074-01	Drop Adapter Fitting
9		9091083-01	9091083-01		9091083-01	9091083-01	Water Inlet Fitting
10		9091140-01	9091140-01		9091140-01	9091140-01	Drain Fitting
11		9051602-01	9051602-01		9051602-01	9051602-01	Cover-Ice Chute
12		9131494-01	9131494-01		9131494-01	9131494-01	Clamp-Ice Chute
13		9131495-01	9131495-01		9131495-01	9131495-01	Ice Chute and Foam Assembly
14		9021116-01	9021116-01		9021116-01	9021116-01	Clip-Hose
15		1051166-01	1051166-01		1051166-01	1051166-01	Bin Control Assembly Set of 2
16		9051614-01	9051614-01		9051614-01	9051614-01	Gasket, Ice Chute
17		9051601-01	9051601-02		9051601-01	9051601-02	Ice Chute, Lower
18		9151170-01	9151169-01		9151170-01	9151169-01	Evaporator
19		9051632-01	9051632-01		9051632-01	9051632-01	Drip Pan
20		9131486-01	9131486-01		9131486-01	9131486-01	Drip Pan Gasket
21		9051611-01	9051611-01		9051611-01	9051611-01	Water Shed
22		1011380-178	1011380-178		1011380-178	1011380-178	Insulation NLA Replaced by #24
23		1011380-179	1011380-179		1011380-179	1011380-179	Insulation NLA Replaced by #24
24		9021140-01	9021140-01		9021140-01	9021140-01	Insulation Replaces 22 and 23
25		9131480-01	9131480-01		9131480-01	9131480-01	Nylon Strap

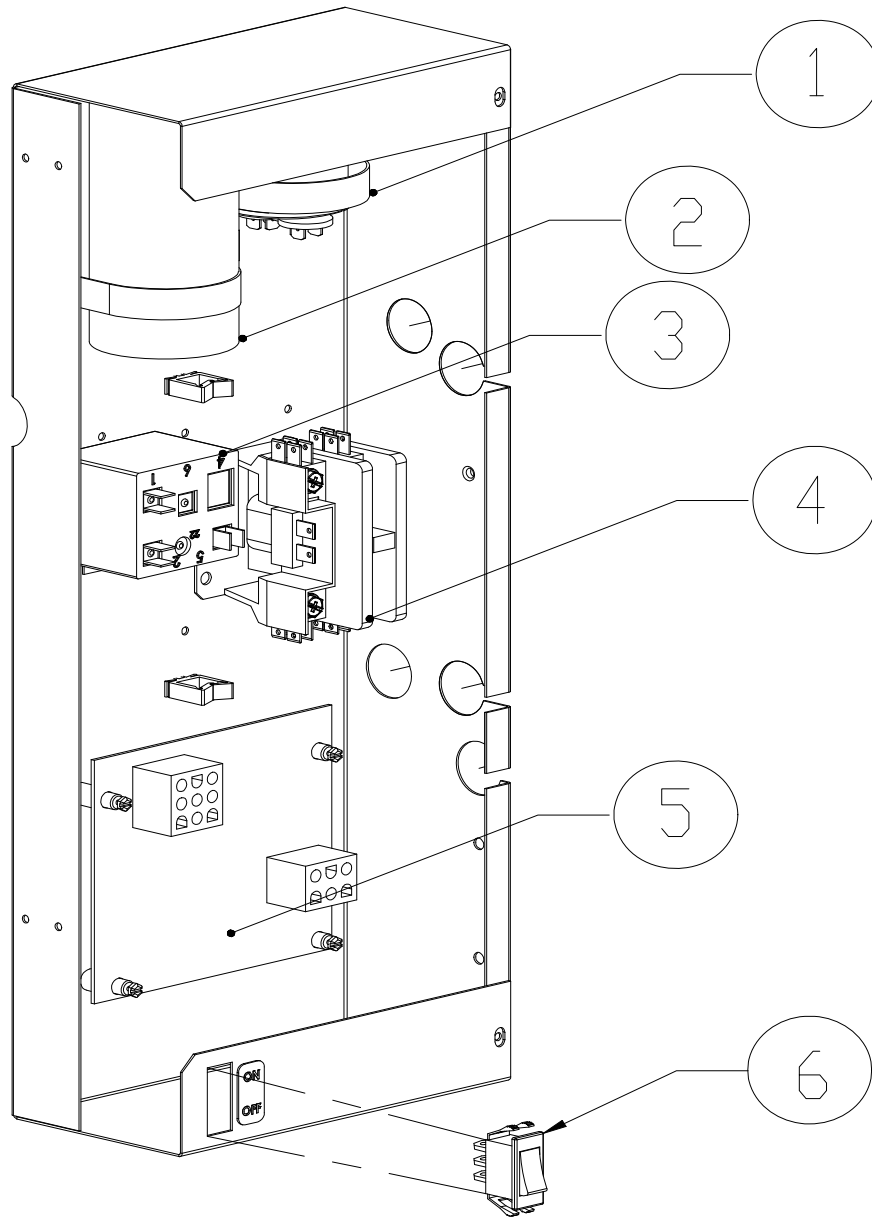

Item No.	Model Number						Description
	GEM0450	GEM0650	GEM0956	MFI0500	MFI0800	MFI1256	
1	See Page 17	See Page 17	See Page 17	See Page 17	See Page 17	See Page 17	Run Capacitor
2	See Page 17	See Page 17	See Page 17	See Page 17	See Page 17	See Page 17	Start Capacitor
3	See Page 17	See Page 17	See Page 17	See Page 17	See Page 17	See Page 17	Compressor Relay
4	9101002-07	9101002-07	9101002-06	9101002-07	9101002-07	9101002-06	Contactator
5	9101335-01	9101335-01	9101335-01	9101335-01	9101335-01	9101335-01	Board
6	9101139-04	9101139-04	9101139-04	9101139-04	9101139-04	9101139-04	Switch

Item No.	Model Number				Description
	GEM0655	GEM0955	MFI0805	MFI1255	
1	See Page 17	See Page 17	See Page 17	See Page 17	Run Capacitor
2	See Page 17	See Page 17	See Page 17	See Page 17	Start Capacitor
3	See Page 17	See Page 17	See Page 17	See Page 17	Compressor Relay
4	9101002-06	9101002-06	9101002-06	9101002-06	Contactator
5	9101335-01	9101335-01	9101335-01	9101335-01	Board
6	9101139-04	9101139-04	9101139-04	9101139-04	Switch

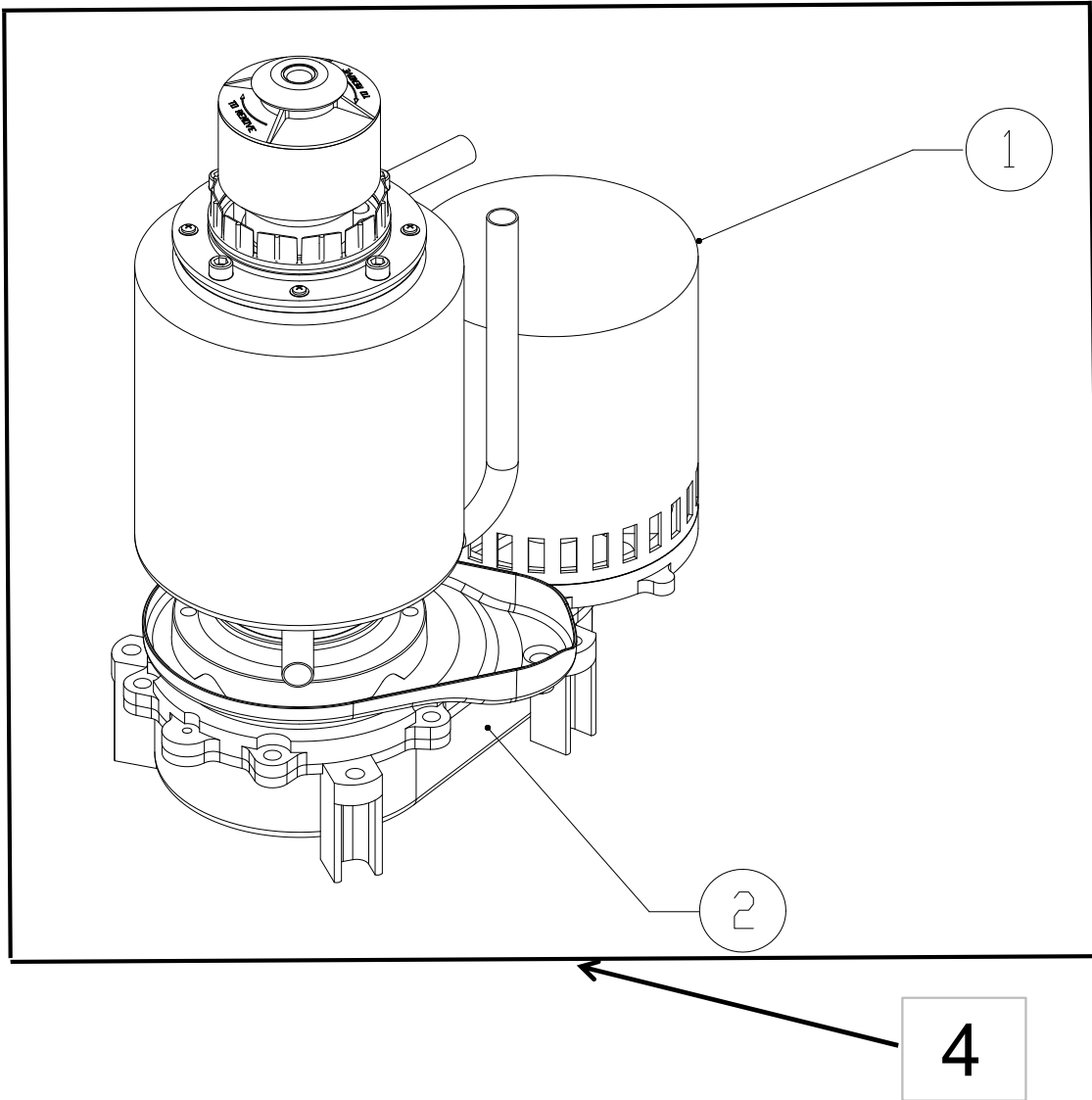

***Note: Complete Assembly includes Drive Motor, Gear Box Assembly and Evaporator Assembly**

Item No.	Model Number						Description
	GEM0450	GEM0650	GEM0956	MFI0500	MFI0800	MFI1256	
1	9161139-01	9161139-01	9161140-01	9161139-01	9161139-01	9161140-01	Drive Motor Only
2	9161141-01	9161141-01	9161141-01	9161141-01	9161141-01	9161141-01	Gear Box Only
	9161127-01	9161127-01	9161126-01	9161127-01	9161127-01	9161126-01	Drive Motor-Gear Box Assy
4	2081044-02	2081044-02	2081044-06	2081044-01	2081044-01	2081044-05	Complete Assembly*

Item No.	Model Number				Description
	GEM0655	GEM0955	MFI0805	MFI1255	
1	9161140-01	9161140-01	9161140-01	9161140-01	Drive Motor Only
2	9161141-01	9161141-01	9161141-01	9161141-01	Gear Box Only
	9161126-01	9161126-01	9161126-01	9161126-01	Drive Motor-Gear Box Assy
4	2081044-04	2081044-06	2081044-03	2081044-05	Complete Assembly*

Lubricants	
6051073-01	Gear Case Lubricant
9131560-01	Grease Needle
6051062-01	Upper Bearing Grease

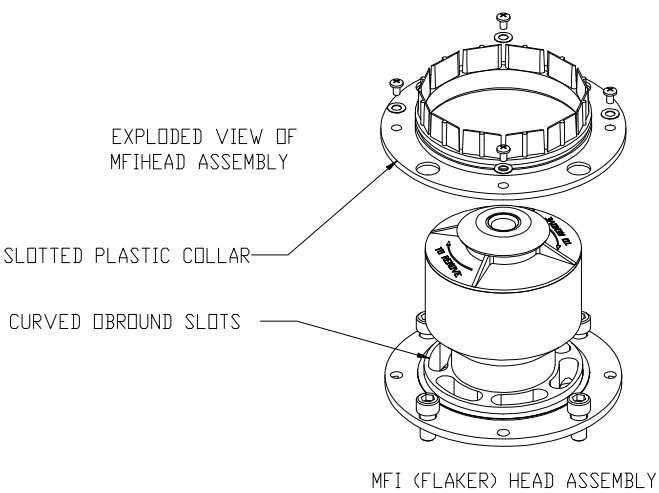
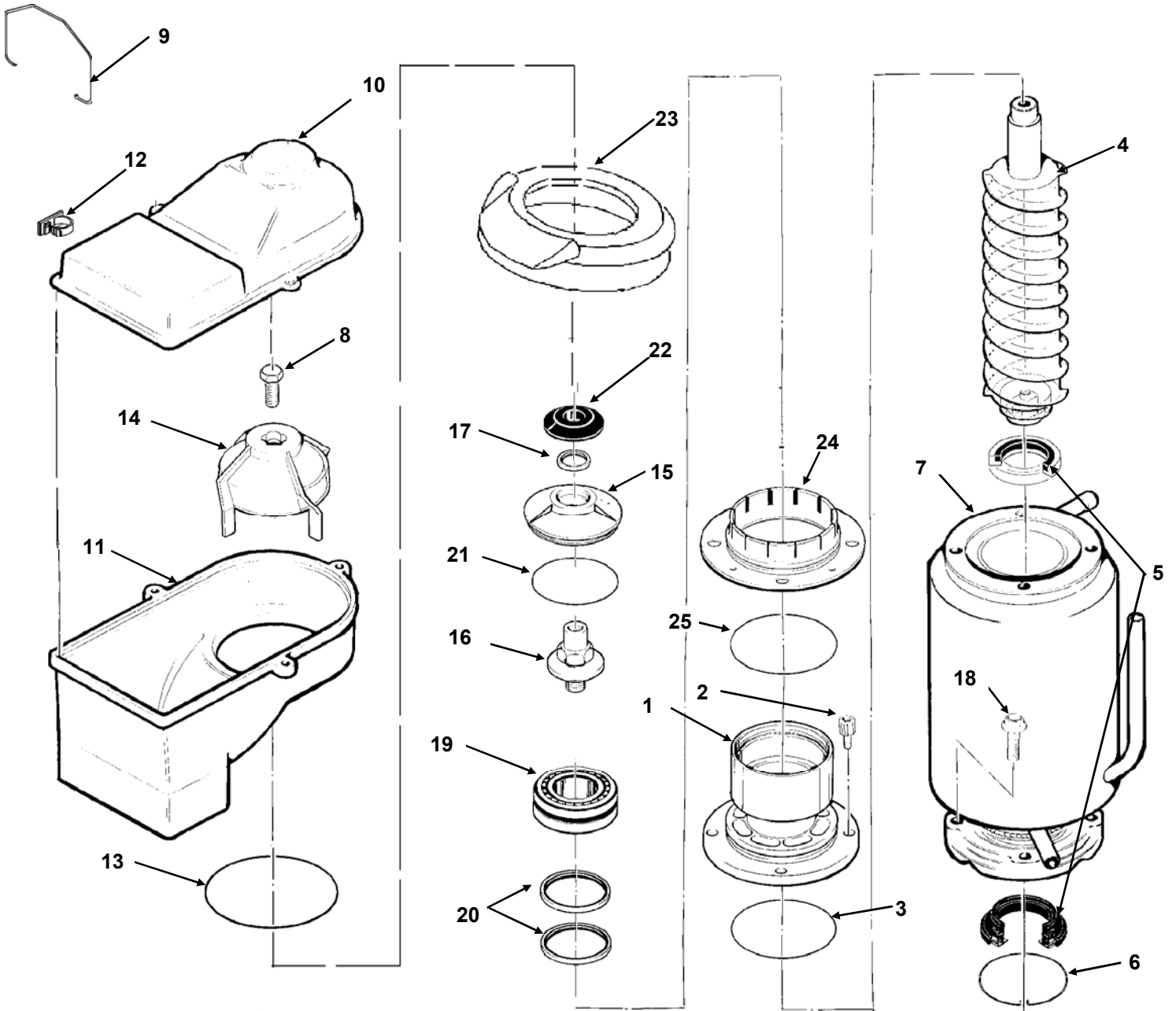

NOTE DIFFERENCE BETWEEN MFI HEAD ASSEMBLY AND GEM HEAD ASSEMBLY

ROUND EXTRUSION HOLES WITH NO SLOTTED PLASTIC COLLAR

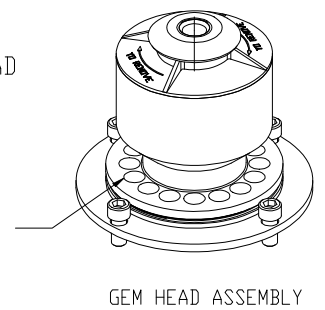

GEM-MFI Series Service Parts

Evaporator

Item No.	Model Number						Description
	GEM0450	GEM0650	GEM0956	MFI0500	MFI0800	MFI1256	
1	1051220-01	1051220-01	1051220-01	1051221-01	1051221-01	1051221-01	Breaker (Includes items 3,15,17,19,21,22,25)
2	9031001-42	9031001-42	9031001-42	9031001-42	9031001-42	9031001-42	Socket Head Screw
3	9051636-01	9051636-01	9051636-01	9051636-01	9051636-01	9051636-01	O-Ring
4	9151167-01	9151167-01	9151196-01	9151167-01	9151167-01	9151196-01	Auger
5	9021142-01	9021142-01	9021142-01	9021142-01	9021142-01	9021142-01	Water Seal
6	9021141-01	9021141-01	9021141-01	9021141-01	9021141-01	9021141-01	Ring, Water Seal
7	9151170-01	9151170-01	9151169-01	9151170-01	9151170-01	9151169-01	Evaporator-Barrel Only
8	9031001-44	9031001-44	9031001-44	9031001-44	9031001-44	9031001-44	Hex Cap Screw
9	9131494-01	9131494-01	9131494-01	9131494-01	9131494-01	9131494-01	Bail Clamp
10	9051602-01	9051602-01	9051602-01	9051602-01	9051602-01	9051602-01	Ice Chute Cover
11	9131495-01	9131495-01	9131495-01	9131495-01	9131495-01	9131495-01	Ice Chute Body with Insulation
12	9021116-01	9021116-01	9021116-01	9021116-01	9021116-01	9021116-01	Drain Hose Clip
13	9051634-01	9051634-01	9051634-01	9051634-01	9051634-01	9051634-01	O-Ring
14	9051603-01	9051603-01	9051603-01	9051603-01	9051603-01	9051603-01	Ice Sweep
15	9151171-01	9151171-01	9151171-01	9151171-01	9151171-01	9151171-01	Breaker Cover
16	9151168-01	9151168-01	9151168-01	9151168-01	9151168-01	9151168-01	Auger Stud
17	9121054-01	9121054-01	9121054-01	9121054-01	9121054-01	9121054-01	Lip Seal
18	9031001-46	9031001-46	9031001-46	9031001-46	9031001-46	9031001-46	Cap Screw
19	9121052-01	9121052-01	9121052-01	9121052-01	9121052-01	9121052-01	Bearing
20	9121053-01	9121053-01	9121053-01	9121053-01	9121053-01	9121053-01	Lip Seal
21	9051635-01	9051635-01	9051635-01	9051635-01	9051635-01	9051635-01	O-Ring
22	9051640-01	9051640-01	9051640-01	9051640-01	9051640-01	9051640-01	Water Shed
23	9051613-02	9051613-02	9051613-02	9051613-01	9051613-01	9051613-01	Insulation Collar
24	N/A	N/A	N/A	9051638-01	9051638-01	9051638-01	Slotted collar
25	N/A	N/A	N/A	9051637-01	9051637-01	9051637-01	O-Ring

Note: Reference Page 13 for Lubricant and Grease Needle

Item No.	Model Number				Description
	GEM0655	GEM0955	MFI0805	MFI1255	
1	1051220-01	1051220-01	1051221-01	1051221-01	Breaker (Includes items 3,15,17,19,21,22,25)
2	9031001-42	9031001-42	9031001-42	9031001-42	Socket Head Screw
3	9051636-01	9051636-01	9051636-01	9051636-01	O-Ring
4	9151167-01	9151196-01	9151167-01	9151196-01	Auger
5	9021142-01	9021142-01	9021142-01	9021142-01	Water Seal
6	9021141-01	9021141-01	9021141-01	9021141-01	Ring, Water Seal
7	9151170-01	9151169-01	9151170-01	9151169-01	Evaporator-Barrel Only
8	9031001-44	9031001-44	9031001-44	9031001-44	Hex Cap Screw
9	9131494-01	9131494-01	9131494-01	9131494-01	Bail Clamp
10	9051602-01	9051602-01	9051602-01	9051602-01	Ice Chute Cover
11	9131495-01	9131495-01	9131495-01	9131495-01	Ice Chute Body with Insulation
12	9021116-01	9021116-01	9021116-01	9021116-01	Drain Hose Clip
13	9051634-01	9051634-01	9051634-01	9051634-01	O-Ring
14	9051603-01	9051603-01	9051603-01	9051603-01	Ice Sweep
15	9151171-01	9151171-01	9151171-01	9151171-01	Breaker Cover
16	9151168-01	9151168-01	9151168-01	9151168-01	Auger Stud
17	9121054-01	9121054-01	9121054-01	9121054-01	Lip Seal
18	9031001-46	9031001-46	9031001-46	9031001-46	Cap Screw
19	9121052-01	9121052-01	9121052-01	9121052-01	Bearing
20	9121053-01	9121053-01	9121053-01	9121053-01	Lip Seal
22	9051635-01	9051635-01	9051635-01	9051635-01	O-Ring
22	9051640-01	9051640-01	9051640-01	9051640-01	Water Shed
23	9051613-02	9051613-02	9051613-01	9051613-01	Insulation Collar
24	N/A	N/A	9051638-01	9051638-01	Slotted collar
25	N/A	N/A	9051637-01	9051637-01	O-Ring

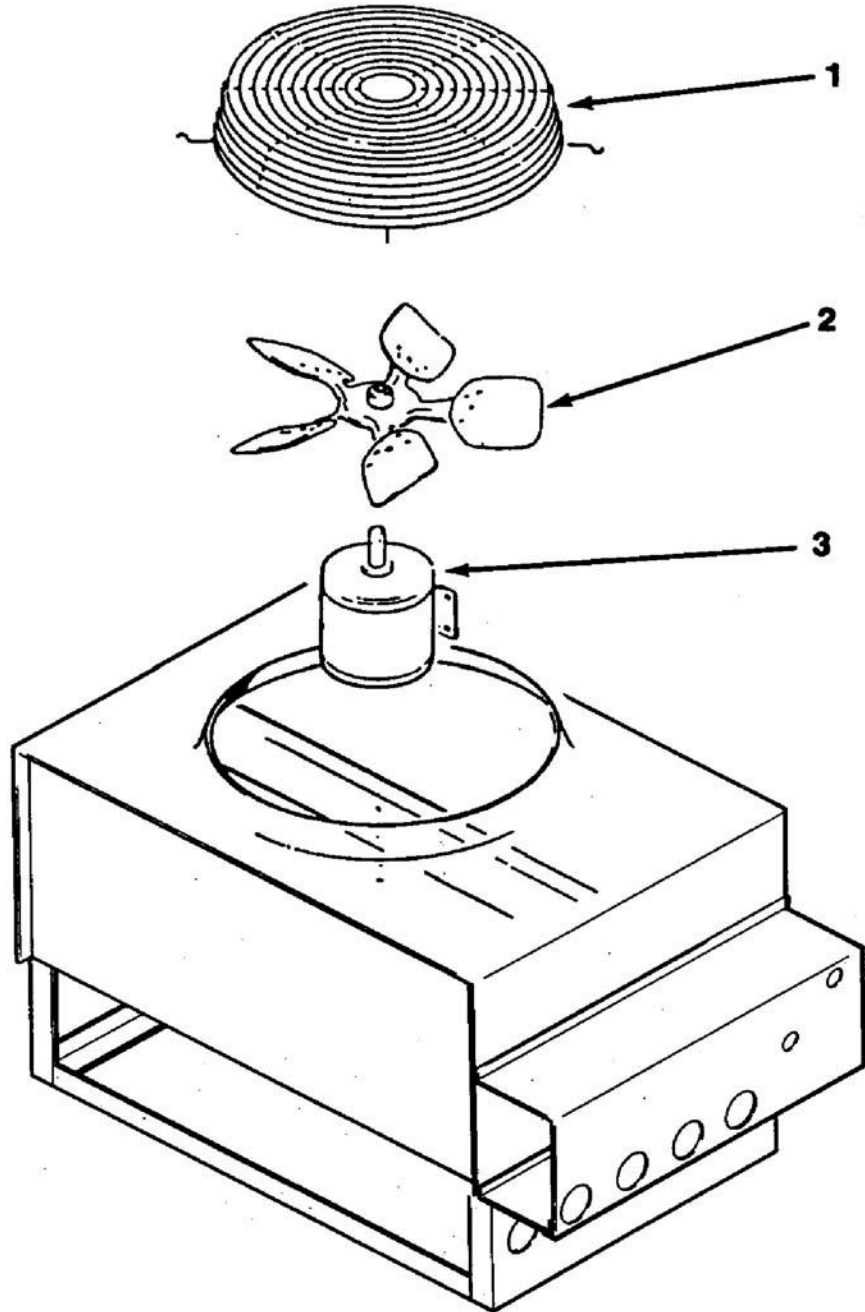

Item No.	Model Number			Description
	GRC1001	GRC1061	GRC1061	
1	9131452-01	9131452-01	9131452-01	Fan Shroud
2	9131490-01	9131490-01	9131490-01	Fan Blade
3	9161121-01	9161121-02	9161121-02	Fan Motor

GEM0650R GEM0956R MFI1256R

Compressor and Starting Components

Version 1 and 2							
Item No.	Model Number						Description
	GEM0450	GEM0650	GEM0956	MFI0500	MFI0800	MFI1256	
1	9181131-11	9181135-11	9181134-11	9181131-11	9181135-11	9181134-11	Compressor Kit
2	N/A	9181009-11	9181009-11	N/A	9181009-11	9181009-11	Run Capacitor
3	9181003-49	9181003-47	9181003-20	9181003-49	9181003-47	9181003-20	Start Capacitor
4	9181004-29	9181010-31	9181010-12	9181004-29	9181010-31	9181010-12	Compressor Relay
5	1011380-233	1011380-125	Internal	1011380-233	1011380-125	Internal	Overload

Item No.	Model Number						Description
		GEM0655	GEM0956		MFI0805	MFI1255	
1		9181135-12	9181130-11		9181135-12	9181130-11	Compressor Kit
2		9181009-09	9181009-16		9181009-09	9181009-16	Run Capacitor
3		9181003-48	9181003-08		9181003-48	9181003-08	Start Capacitor
4		9181010-04	9181010-27		9181010-04	9181010-27	Compressor Relay
5		1011380-130	1011380-139		1011380-130	1011380-139	Overload

Reference the compressor model number to insure the correct compressor starting components are ordered.

	9181130-11	RS97C1E-CAZ
	9181134-11	RS70C1E-PFV
	9181135-11	RS55C1E-PAA
	9181135-12	RS55C1E-PAZ

The following compressor kits are No Longer Available and have been replaced with new kits

Old Kit Pn	Replaced By	Includes Compressor
9181130-11	1051188-01	9181147-11
9181134-11	1051187-01	9181145-11
9181135-11	1051175-01	9181137-11
9181135-12	1051176-01	9181138-11

Version 3-4-5							
Item No.	Model Number						Description
		GEM0650	GEM0956		MFI0800	MFI1256	
1		9181137-11	9181145-11		9181137-11	9181145-11	Compressor Kit
2		9181009-25	9181009-19		9181009-25	9181009-19	Run Capacitor
3		9181003-50	9181003-52		9181003-50	9181003-52	Start Capacitor
4		9181010-14	9181010-27		9181010-14	9181010-27	Compressor Relay
5		9181005-45	Internal		9181005-45	Internal	Overload

Item No.	Model Number						Description
		GEM0655	GEM0956		MFI0805	MFI1255	
1		9181138-11	9181147-11		9181138-11	9181147-11	Compressor Kit
2		9181009-26	9181009-17		9181009-26	9181009-17	Run Capacitor
3		9181003-51	9181003-54		9181003-51	9181003-54	Start Capacitor
4		9181010-32	9181010-01		9181010-32	9181010-01	Compressor Relay
5		9181005-46	Internal		9181005-46	Internal	Overload

Reference the compressor model number to insure the correct compressor starting components are ordered.

	9181147-11	RST80C1E-PFZ
	9181145-11	RST70C1E-PFV
	9181137-11	RST55C1E-CAA
	9181138-11	RST55C1E-CAB

<u>Number</u>	<u>Description</u>	<u>Replaced By</u>
1011380-02	WATER SEAL	9021142-01
1011380-10	LIP SEAL	9121053-01
1011380-11	LIP SEAL	9121054-01
1011380-13	BREAKER COVER	9151171-01
1011380-163	OIL 1 CONTAINER	6051073-01
1011380-168	RETAINING RING	9021141-01
1011380-172	EVAPORATOR TALL	9151169-01
1011380-175	BREAKER	1051220-01
1011380-178	XINSULATION COLLAR R/B-1011447-193**	1011447-193
1011380-179	INSULATION COLLAR R/B-1011447-193**	1011447-193
1011380-186	GEARMOTOR ASSY 115V	9161127 01
1011380-187	GEARMOTOR ASSY 230V	9161126-01
1011380-189	GEARCASE KIT	9161141-01
1011380-202	BEARING	9121052-01
1011380-225	AUGER	9151167-01
1011380-226	AUGER	9151196-01
1011380-230	GREASE NEEDLE	9131560-01
1011380-27	DRIP PAN	9051632-01
1011380-37	CAP SCREW	9031001-42
1011380-38	HEX CAP SCREW	9031001-42
1011380-44	SOCKET HEAD SCREW	9031169-02
1011380-46	AUGER STUD	9151168-01
1011380-67	DRIVE MOTOR 115V	9161139-01
1011380-68	DRIVE MOTOR 208-230V	9161140-01
1011380-80	O-RING	9051636-01
1011380-81	O-RING	9051634-01
1011380-82	O-RING	9051635-01
1011380-83	DRIP PAN GASKET	9131486-01
1011380-85	WATER SHED	9051611-01
1011380-86	WATER SHED	9051640-01
1011382-01	BREAKER HEAD MFI	1051221-01
1011382-02	SLOTTED COLLAR	9051638-01
1011382-04	O-RING	9051637-01
1011382-09	EVAPORATOR SHORT	9151170-01
1011447-193	INSULATION	9021140-01
9131496-01	FREEZER ASSY FLA SM 115V	2081044-01
9131496-02	X FREEZER ASSY NUG SM 115V	2081044-02
9131496-03	FREEZER ASSY FLA SM 230V	2081044-03
9131496-04	FREEZER ASSY NUG SM 230V	2081044-04
9131496-05	FREEZER ASSY FLA LG 230V	2081044-05
9131496-06	X FREEZER ASSY NUG LG 230V	2081044-06