



B55

## Features

- Application storage capacity from 242 lbs (110 kg) to 854 lbs (388 kg).
- Multiple bin tops provide an easy solution for mounting ice makers on different sized bins.
- Polyethylene bin liner is insulated with foam for maximum ice preservation – 1.5" to 3" (38 mm to 76 mm).
- 31" deep for use where space is at a premium.
- Built-in ice scoop holders on certain models.
- Sturdy leg design – 6" (152 mm) adjustable NSF approved legs – standard.
- Durable aluminum finish.

## Bin Accessories

Ice-O-Matic Part Number	Description
1011517-22	Plastic ice shovel
1011517-23	Hanging bracket for ice shovel
1011517-24	46.5" Plastic paddle
1051517-29	Hanging bracket for ice paddle
9051127-01	82 Ounce ice scoop

## Single Ice Machine Configurations

Ice-O-Matic offers a full line of bins for most applications. From low profile slope-front bins to high capacity space-saving uprights, we have a bin to meet any need. The following table will help you create the system you need in a safe and cost effective manner.

Bin Model No.	Style	Application Bin Storage lbs (kgs)	Approximate Shipping Weight lbs (kgs)	CIM Series Cube Makers	ICE Series Cube Makers			Nugget Ice Makers	Flake Ice Machine
				30" (762 mm) wide	22" (559 mm) wide	30" (762 mm) wide	48" (1,219 mm) wide	21" (533 mm) wide	21" (533 mm) wide
<b>B25PP*</b>	Slope Front	242 (110)	74 (34)	△△	KBT19	△△	N/A	KBT19	KBT19
<b>B40PS</b>	Slope Front	344 (156)	103 (47)	△△	KBT19	△△	N/A	KBT19	KBT19
<b>B42PS</b>	Slope Front	351 (160)	99 (45)	N/A	△△	N/A	N/A	KBT24	KBT24
<b>B55PS</b>	Slope Front	510 (232)	125 (57)	△△	KBT19	△△	N/A	KBT19	KBT19
<b>B110PS</b>	Slope Front	854 (388)	163 (74)	BPF-1***	N/A	BPF-1***	△△	KBT23	KBT23

△△ Kit not required. △△\*\* Ice clumping issues may arise. \* Rotocast finish N/A Not Applicable  
\*\* ICE1506 is compatible with B700-30, B1000-48, B1300-48, B1325-60 & B1600-60. \*\*\* BPF-1 used with B110 ONLY. If you have an older model B100 bin use the KBT5.

## Side-by-Side Ice Machine Configurations

There are times when it is desirable to install 2 ice machines side by side on a bin. The reasons may range from gaining maximum output to creating redundancy. Ice-O-Matic offers an array of kits and bins with custom order tops for just such applications. The following table will help you create the system you need in a safe and cost effective manner.

Bin Model No.	Style	Application Bin Storage lbs (kgs)	Approximate Shipping Weight lbs (kgs)	CIM Series Cube Makers	ICE Series Cube Makers			Nugget Ice Makers	Flake Ice Machine
				30" (762 mm) wide	Two 22" (559 mm) wide	Two 30" (762 mm) wide	Two 48" (1,219 mm) wide	Two 21" (533 mm) wide	Two 21" (533 mm) wide
<b>B25PP*</b>	Slope Front	242 (110)	74 (34)	N/A	N/A	N/A	N/A	N/A	N/A
<b>B40PS</b>	Slope Front	344 (156)	103 (47)	N/A	N/A	N/A	N/A	N/A	N/A
<b>B42PS</b>	Slope Front	351 (160)	99 (45)	N/A	N/A	N/A	N/A	N/A	N/A
<b>B55PS</b>	Slope Front	510 (232)	125 (57)	N/A	N/A	N/A	N/A	N/A	N/A
<b>B110PS</b>	Slope Front	854 (388)	163 (74)	N/A	N/A	N/A	N/A	KBT22	KBT22

○ Must use remote or water cooled model only. △△ Kit not required. \* Rotocast finish N/A Not Applicable  
○\* Must use remote or water cooled model only; ice clumping issues may arise. △△\*\* Ice clumping issues may arise.

SLOPE FRONT STORAGE BINS



SLOPE FRONT STORAGE BINS

Dimensions

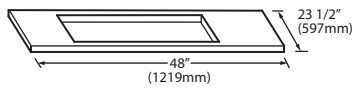
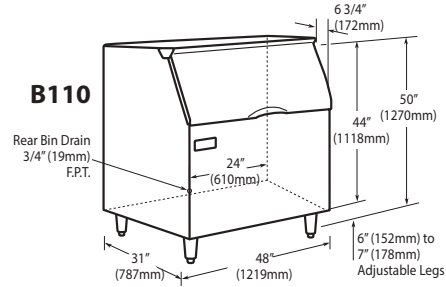
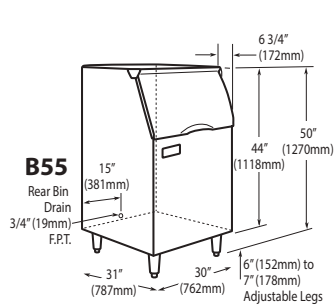
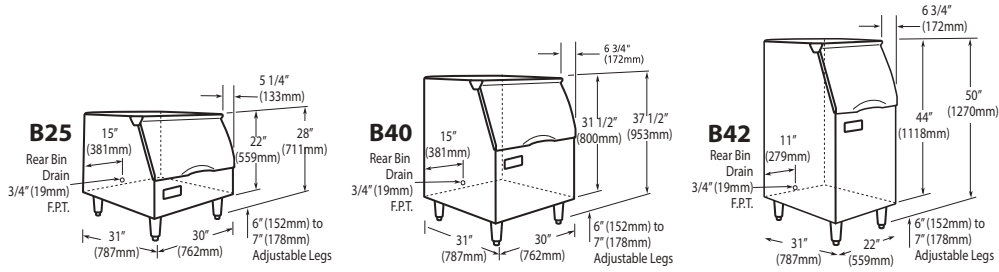

**KBT5**  
Bin Top for 30" (762 mm) ICE series cuber including the ICE1506 family on a B100 bin

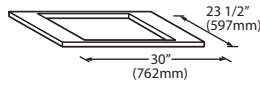

**KBT19**  
Bin Top for 30" (762mm) bins with 22" (559mm) ICE Series Cube Ice Makers GEM Series Ice Makers & MFI Series Ice Makers

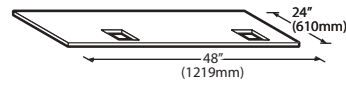

**KBT22**  
Bin Top for 48" (1219mm) bins with (2) 21" (533mm) wide GEM Series Ice Makers & MFI Series Ice Makers

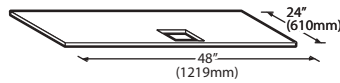

**KBT23**  
Bin Top for 48" (1219mm) bins with (1) 21" (533mm) wide GEM Series Ice Makers & MFI Series Ice Makers

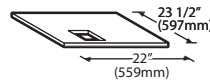

**KBT24**  
Bin Top for 22" (559mm) bins with (1) 21" (533mm) wide GEM Series Ice Maker

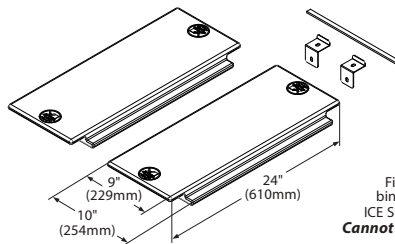

**BPF-1**  
Filler Panel for B110 bins with 30" (762mm) ICE Series Cube Ice Makers **Cannot be used with the B100**

NOTES:

Approx. Shipping Weight lbs (kg): B110 191 (87 kg) • B55 170 (77 kb) • B25 95 (43 kg) • B40 135 (61 kg) • B42 135 (61 kg)