

COLD CARB ICE COOLED DISPENSER SERIES 2308 - DROP IN

Installation and Service Manual

PN 28-0720/05

11/10/09



LANCER

6655 Lancer Blvd.
San Antonio, Texas 78219

To order parts, call
Customer Service: 800-729-1500
Warranty/Technical Support: 800-729-1550
Email: custserv@lancercorp.com
www.lancercorp.com



ISO 9001:2000 Quality System Certified

TABLE OF CONTENTS

SPECIFICATIONS.....	3
1. INSTALLATION OF LANCER ICE COOLED DISPENSER.....	3
1.1 RECEIVING.....	3
1.2 UNPACKING.....	3
1.3 SELECTING A COUNTER LOCATION.....	3
1.4 WATER SUPPLY.....	3
1.5 ELECTRICAL SUPPLY.....	4
1.6 INSTALLATION OF THE DISPENSER AND PUMP DECK.....	4
1.7 CONNECTION OF THE EQUIPMENT.....	5
1.8 START UP.....	5
1.9 ADJUSTING WATER FLOW.....	6
1.10 ADJUSTING WATER TO SYRUP RATIO (BRX).....	7
1.11 CONVERTER BLOCK.....	7
2. MVU OPERATION.....	8
2.1 MVU PLUMBING DIAGRAM - MAKING CONNECTIONS TO THE MVU.....	8
2.2 SYSTEM STARTUP.....	8
2.3 PROGRAM MULTI VALVE UNIT (MVU).....	9
2.4 SET MVU FOR FLAVOR SHOTS.....	10
2.5 FLOW RATE CHECK.....	12
2.6 RATIO PROCESS.....	13
2.7 PORTION CONTROL PROGRAMMING (MVU) (NO TOPOFF).....	14
2.8 PORTION CONTROL PROGRAMMING WITH TOP-OFF (MVU).....	15
2.9 SHOT SIZE PROGRAMMING.....	17
2.10 DISPENSER OPERATION.....	18
2.11 FINAL ASSEMBLY.....	19
3. RECOMMENDED SERVICES AND MAINTENANCE.....	20
3.1 SCHEDULED.....	20
3.2 CLEANING AND SANITIZING SYSTEMS.....	20
3.3 CLEANING AND SANITIZING BAG-IN-BOX (BIB) SYSTEMS.....	21
3.4 VALVES.....	21
3.5 ICE BIN COMPARTMENT ON ALL ICE CHESTS.....	22
4. TROUBLESHOOTING.....	23
4.1 NO CARBONATION.....	23
4.2 NOISY CARBONATOR PUMP.....	23
4.3 VALVES INOPERABLE.....	23
4.4 LED BLINKING 4 BLINKS PER SECOND.....	24
4.5 LED BLINKING 1 BLINK PER SECOND.....	24
5. ILLUSTRATIONS, PARTS LISTINGS AND WIRING DIAGRAMS.....	26
5.1 SERIES 2300 DROP-IN.....	26-27
5.2 REMOTE PUMP ASSEMBLY.....	28-29
5.3 TOWER ASSEMBLY, BEVARIETY MVU.....	30-31
5.4 MVU ASSY.....	32
5.5 NOZZLE, HYBRID MULTI-FLAVOR.....	32
5.6 ICE COOLED UNIVERSAL WIRING DIAGRAM WITH BIN LID SWITCH.....	33
5.7 ICE COOLED UNIVERSAL WIRING DIAGRAM WITH BIN LID SWITCH AND MVU.....	34
5.8 ACCESSORIES.....	35

SPECIFICATIONS

DIMENSIONS

Cabinet	23 inches x 23 inches	(58.42 cm x 58.42 cm)
Rim	25 inches x 25 inches	(63.50 cm x 63.50 cm)
Height (without legs)	19-1/2 inches	(49.53 cm) above counter (to top of valves)
	23 inches	(58.42 cm) below counter

WEIGHT

Shipping	296 pounds	(134.26 kg)
Empty	253 pounds	(114.75 kg)
Operating	365 pounds	(165.5 kg)

ICE BIN CAPACITY

100 pounds (45.46 kg)



WARNING!

Pouring coffee, tea, and like substances into the drain can cause clogging.

1. INSTALLATION OF LANCER ICE COOLED DISPENSER

1.1 RECEIVING

Each unit is tested under operating conditions and inspected before shipment. At the time of shipment, the carrier accepts responsibility for the unit. Upon receiving the unit, carefully inspect the carton for visible damage. If damage exists, have the carrier note the damage on the freight bill and file a claim with carrier. Responsibility for damage to the unit lies with the carrier.

1.2 UNPACKING

- The ice cooled dispenser is shipped in a corrugated shipping carton. Remove the corrugated shipping carton from the unit.
- Remove the parts from the ice compartment.
- Inspect the unit and parts for concealed damage. If damage exists, notify delivering carrier and file a claim.

1.3 SELECTING A COUNTER LOCATION

- Select a counter location close to a properly grounded electrical outlet and a water supply that meets the requirements specified in Section 1.4 below.
- The counter location must be able to safely support a minimum of 365 pounds (165.5 kg) after the counter cutout is made.

1.4 WATER SUPPLY

- Provide an adequate potable water supply. The water supply line must be at least a 1/2 inches (12.7 mm) pipe. Water pressure exceeding 50 PSI is regulated by a pressure regulator on the pump deck. Water pressure below 40 PSI will require a booster pump.
- Install a shut-off valve in the water line feeding the deck. If a separate water line is run for plain water, ensure that it also has a shut-off valve.



WARNING!

Use a filter in the water line to avoid damage to the dispenser.

- C. The carbonator pump is equipped with a strainer on the inlet side. A water supply containing any appreciable quantity of silt, fine sand, or other debris requires a filter ahead of the pump deck. Clean the filter cartridge periodically, depending on the condition of the water. Failure to do so may starve the pump of water, causing it to burn out, and voiding the warranty.

1.5 ELECTRICAL SUPPLY



WARNING!

The dispenser must be properly electrically grounded to avoid serious injury or fatal electrical shock. The power cord has a three-prong grounded plug. If a three-hole grounded electrical outlet is not available, use an approved method to ground the unit. Follow all local electrical codes when making connections. Each dispenser must have a separate electrical circuit. Do not use extension cords. Do not connect multiple electrical devices on the same outlet.

ALWAYS disconnect power to the dispenser before attempting any internal maintenance.

Only qualified personnel should service the internal components of the dispenser. Avoid any contact with water when plugging in the dispenser.

- A. Locate a standard 20 AMP, 110 VAC, 60 Hz single phase electrical power outlet with ground connectors for the dispenser and pump deck.

1.6 INSTALLATION OF THE DISPENSER AND PUMP DECK

- A. Inspect the counter location where the dispenser will be installed. Verify that the counter is strong enough to safely support a 365 pound (165.5 kg) load, after the counter cutout is made.
- B. Verify that the unit will fit in the location. See below for the counter cutout dimensions.

NOTE: The unit can extend up to 23 inches (58.42 cm) below the counter, including the shipping risers. It is recommended to keep the shipping risers attached to the dispenser. If the dispenser ever requires removal, the shipping risers will protect the inlet tubes from being damaged.

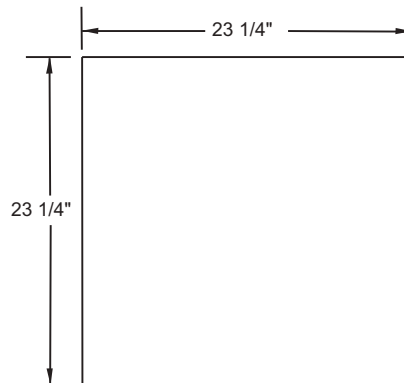

Counter Cutout for dispenser

C. After the counter cutout is made, lower the dispenser into the counter.

NOTE: In order to ensure unit drainage and proper carbonation, it is necessary for the dispenser to be level, front to back and side to side.

D. Position the pump deck under the counter within close proximity to the dispenser. The pump deck must be on a level surface and have adequate electrical utilities available.

1.7 CONNECTION OF THE EQUIPMENT

A. Position the CO₂ gas tank in the desired location. Assemble the high pressure regulator to the CO₂ gas tank and run the jumper line to the low pressure regulator.

B. Attach the CO₂ gas line to the carbonator by attaching the line from the high pressure regulator to the CO₂ inlet. The setting of the high pressure CO₂ gas regulator should be 75 PSI.



WARNING!

Do not turn on CO₂ at this time.

C. Position the syrup pumps in the desired location. Attach the CO₂ gas lines leading from the low pressure regulator to these pumps.

D. Connect the syrup lines from the pumps to the appropriate inlets at the front of the unit. The syrup inlets are identified at the bottom of the unit.

E. Connect the water inlet line to the pump. Complete the water line connection between the pump and the water inlet to the carbonator at the bottom of the dispenser.

F. Provide a suitable drain in the plumbing system and attach the 3/4 inch (1.90 cm) diameter schedule 40 PVC drains to it. The drip pan drainage outlet is located at the right rear of the unit. The ice water drainage outlet is located at the right front of the unit.

G. Be sure to place the ice trap in the drain outlet inside the ice bin **before** filling with ice. This device holds the ice away from the drain outlet, allowing the ice water to drain properly.

H. Plug in the transformer box to a standard 20 AMP, 110 VAC, single phase outlet. The unit will internally convert the 110 VAC to 24 VAC.

1.8 START UP

A. After all connections to water, CO₂ gas, electrical power, and syrup pumps are made, check for leaks.

B. Be sure the Bag-In-Box contains syrup.



WARNING!

Do not operate the carbonator pump deck with the water supply turned off.

C. Turn on water. Open the pressure relief valve on the carbonator tank by flipping up the valve cap lever, and hold it open until water flows from the relief valve. Close (flip down) the relief valve and turn on the CO₂ gas.

D. To fill all lines with water, cycle the carbonator several times by operating the dispensing valves.

1. Ensure a good flow of plain water is established from each valve.

2. Turn on CO₂ at source and ensure that the HP regulator is set at 75 PSIG.

3. Operate valves until unit gases out.

4. Plug in carbonator pump motor. Pump Deck will automatically start.

5. Activate carbonated water valves so that the carbonator pump cycles several times and a good flow of carbonated water is established.
6. A low pressure gas regulator controls the flow of syrup to each dispensing valve. Connect BIB connectors to BIB's. Set LP regulator to 65 PSIG. Activate all valves to purge air from the syrup lines.

NOTE: The unit will cycle on for 5.5 seconds, shut down, and immediately start again and run for additional 5.5 second intervals until the water level reaches the probe.

- E. The dispenser bin should now be filled with ice cubes one inch below the level of the door opening.

1.9 ADJUSTING WATER FLOW

- A. The water flow can be adjusted to either 1.25 ounces/second (37 ml/sec) or 2.5 ounces/second (74 ml/sec) on all dispensing valves, using the following procedure.

NOTE: The unit should have ice on the cold plate for a least one hour before you attempt to brix the valves. The drink temperature should be no higher than 40°F (4.4°C) when the ratio is set. This is done after the unit has ice in the ice bin.

- C. Slide the ID panel up until the flow controls are exposed (see below).
- D. Remove the nozzle by twisting counterclockwise and pulling down.
- E. Remove the diffuser by pulling down.
- F. Install Lancer yellow syrup separator (PN 54-0031) in place of the nozzle.
- G. Activate the dispensing valve to fill the separator syrup tube.
- H. Hold a brix cup under the syrup separator and dispense water and syrup into the cup for four seconds. Divide the number of ounces (ml) of water in the cup by four to determine the water flow rate per second.
- I. To obtain the proper flow, use a screwdriver to adjust the water flow control.
- J. Repeat process for each valve.

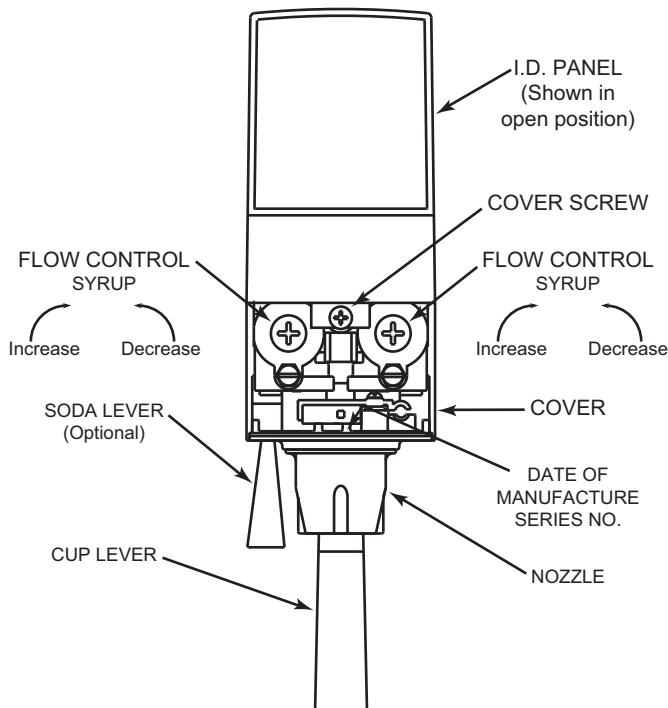

Valve Adjustments

1.10 ADJUSTING WATER TO SYRUP RATIO (BRIX)

- A. Hold the brix cup under the syrup separator and activate valve. Check ratio (brix).
- B. To obtain the proper ratio, use screwdriver to adjust syrup flow control (see Figure 2).
- C. Remove syrup separator.
- D. Install diffuser and nozzle.
- E. Slide ID panel DOWN.
- F. Repeat process for each valve.

NOTE: When re-assembling valves with o-rings, ensure the o-ring is lubricated with an FDA-approved lubricant or water to prevent leakage or damage to the o-ring.

1.11 CONVERTER BLOCK

- A. Set the converter block to provide either plain or carbonated water, depending on the product. The alignment of the dot on the converter block signifies the active port (plain water or carbonated water):

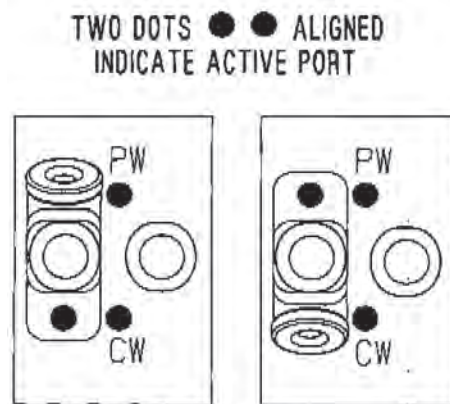

- B. To remove the converter block, use a small screwdriver in the blind hole to pry the converter block out. Applying pressure opposite the blind hole (dot side) will facilitate removing the converter block:

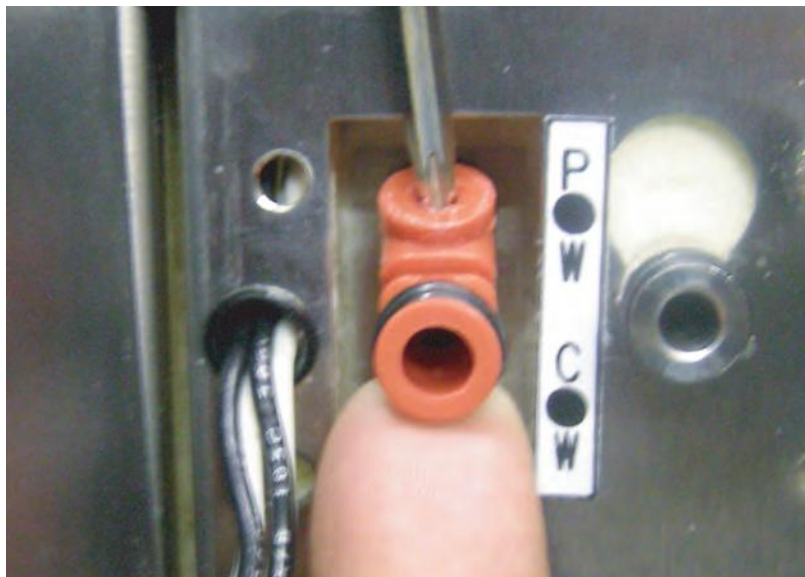

2. MVU OPERATION

2.1 MVU PLUMBING DIAGRAM - MAKING CONNECTIONS TO THE MVU

- A. Valves 1-3 and 6-8 are in the normal positions on the tower; however, the MVU is plumbed as shown in the diagram below. Position A is syrup inlet #4 on the cold plate. Position D is syrup inlet #5. Positions B, C, E, and F on the MVU connect in the positions shown on the illustration of the Configurator block. These positions (B, C, E, F) are all ambient (bypass the cold plate).

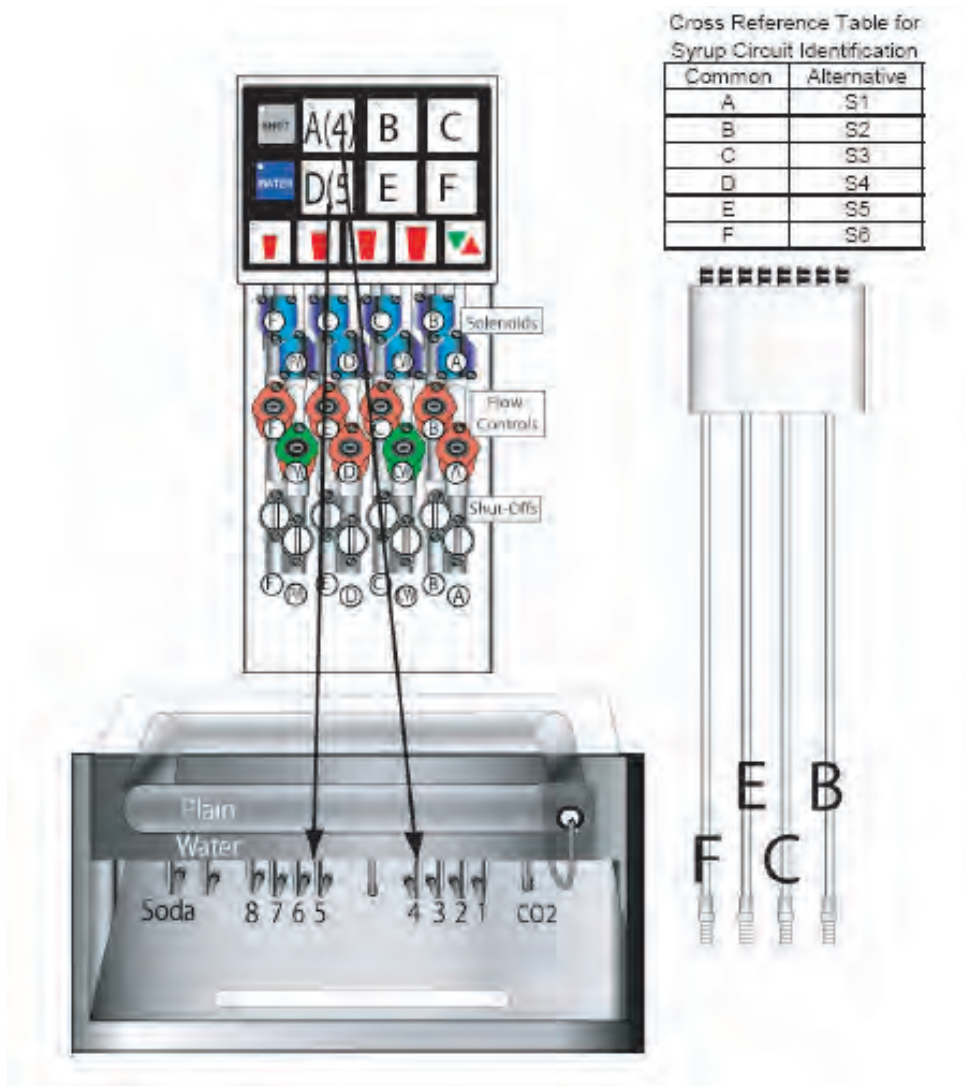

2.2 SYSTEM STARTUP

- Turn on water and purge lines.
- Turn on CO2 and gas out dispenser.
- Plug in carbonator pump.
- Cycle valves two times.
- Turn on CO2 to BIB pumps.
- Pour several drinks.
- Prime for flavor shots.
- Prime for beverages.

2.3 PROGRAM MULTI VALVE UNIT (MVU)

Set MVU Buttons as Carbonated, Non-Carbonated, or Flavor Shot Only.

The MVU can be programmed to serve soda or plain water beverages as well as a flavor shot from each of the beverage positions on the valve.

To enter the programming mode on the MVU and assign water type to each individual brand (Carbonated or Non-carb):

A. Press both A and C brand buttons at the same time on the MVU panel for five seconds.

1. The "Pour/Cancel" LED will illuminate. The "SHOT" LED will blink one time.

2. Brands that are enabled for drinks will have illuminated LED's:

Lights on = non-carb

Lights flashing = carb

Lights off = no water (deactivated unless set for shot)

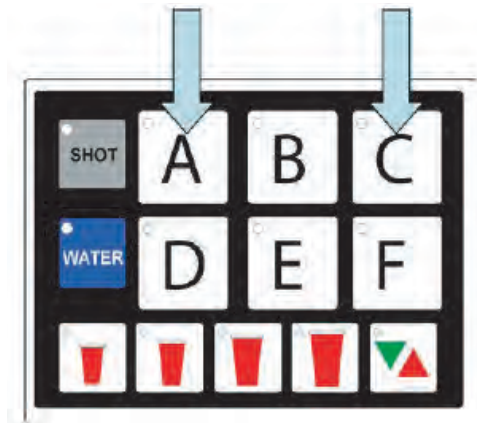

B. Press a Brand button to change that beverage from "water off" to "plain water on".

1. LED will illuminate and stay on for non-carb beverages.

C. Press the same brand button again to switch from non-carb to carb.

1. Press the button one more time to turn the water off for that valve (if position is used for a flavor shot only).

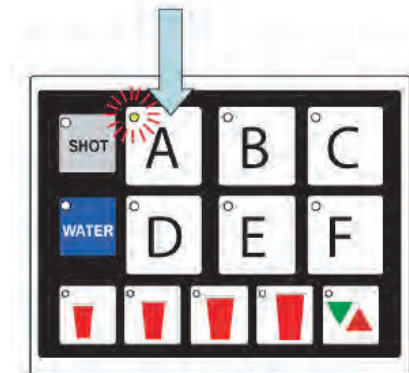

D. Repeat this process for each brand.

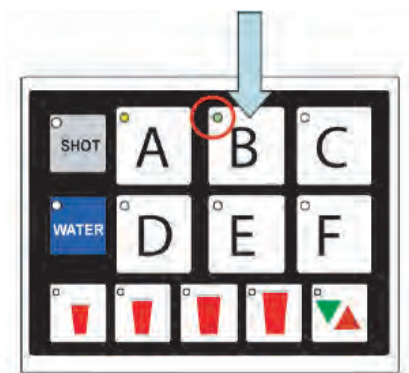

E. Press the Pour/Cancel button to lock the changes in place and exit the programming mode.

NOTE: The Program will save automatically in 60 seconds if no additional changes are made in that time frame; however, you can exit any time within the 60 second window by pressing Pour/Cancel. The changes you've made will be saved.

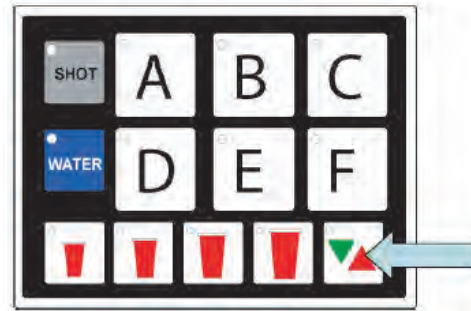

2.4 SET MVU FOR FLAVOR SHOTS

A. Press both A and C brand buttons (at the same time) on the MVU panel for five seconds to get into programming mode.

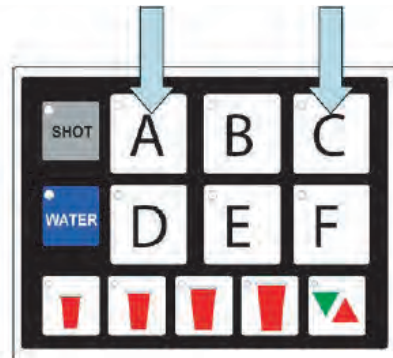

B. Press the "Shot" button.

1. The "Shot" button will illuminate.
2. Brands enabled for shots will be illuminated.

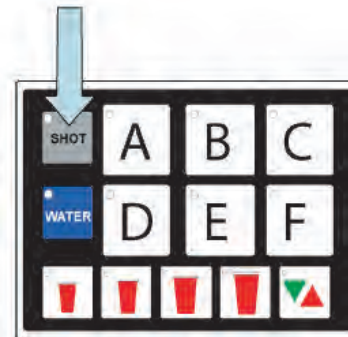

C. Press the "Brand" button to turn the shot mode for that brand on or off.

1. The shot mode is "ON" in the illustration.

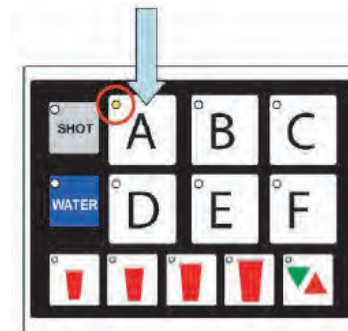

D. Press “Shot” again to return to “Drink Type Selection”

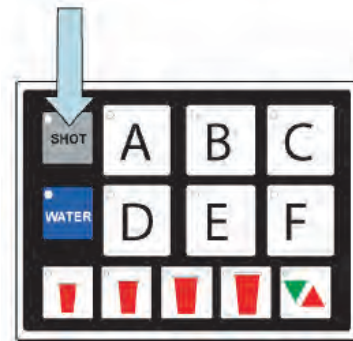

E. Press the Pour/Cancel Button to lock the changes in place and exit the programming mode.

NOTE: The Program will save automatically in 60 seconds if no additional changes are made in that time frame; however, you can exit any time within the 60 second window by pressing Pour/Cancel. The changes you’ve made will be saved.

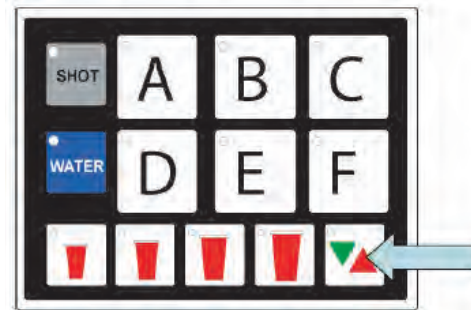

2.5 FLOW RATE CHECK

The Dispenser's water flow rate can be checked/calibrated using the on board computer as a timer. To check/adjust flow rate:

- A. Remove splashguard and module cover to expose flow controls and solenoids.
 1. All active brands should have their shutoffs in the open position as illustrated below.
CW = Carbonated Water (sparkling)
PW = Plain Water (still)

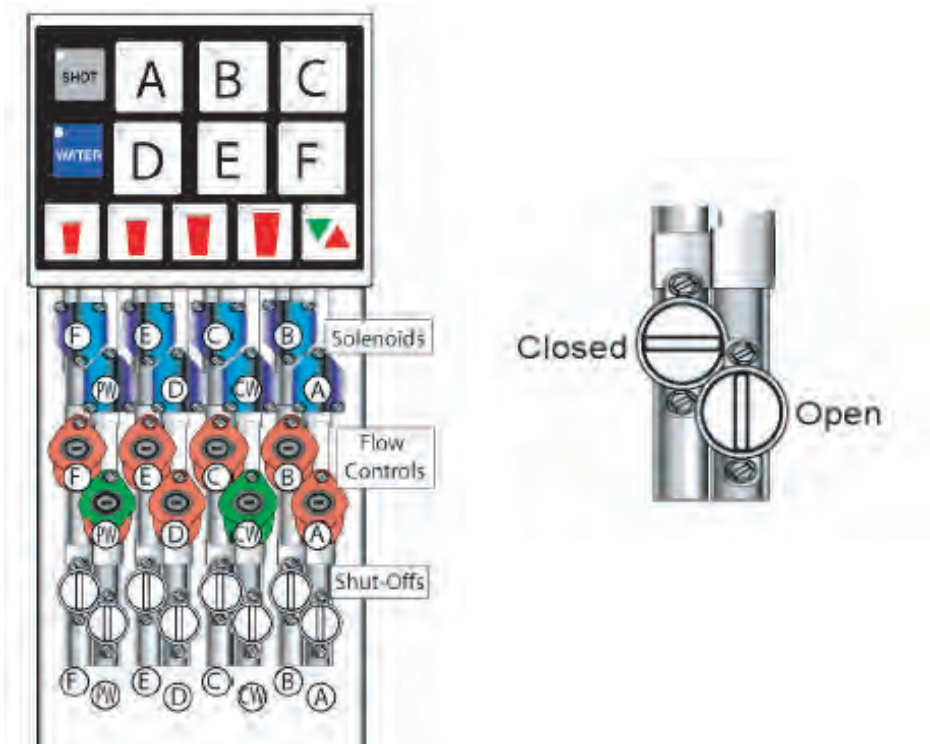

- B. Press the A and B buttons at the same time for five seconds.
 1. The Pour/Cancel button will illuminate and the shot LED will blink 5 times.

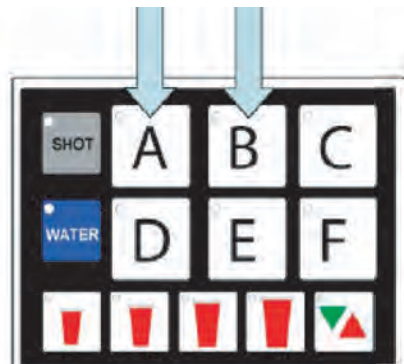

C. Remove outer nozzle and insert syrup separator.

1. This is important to do during flow rate check so you can determine if the separator has been properly installed.

NOTE: Water will leak through to the syrup chamber if not properly installed.

D. Place a ratio cup under the nozzle and press a brand button.

1. The brand's water module will open and pour for four seconds.

NOTE: Only water will pour during the flow rate check.

E. Check for 10 oz of water in the ratio cup.

1. If above or below 10 oz, adjust the water flow control (shown on previous page) and recheck.

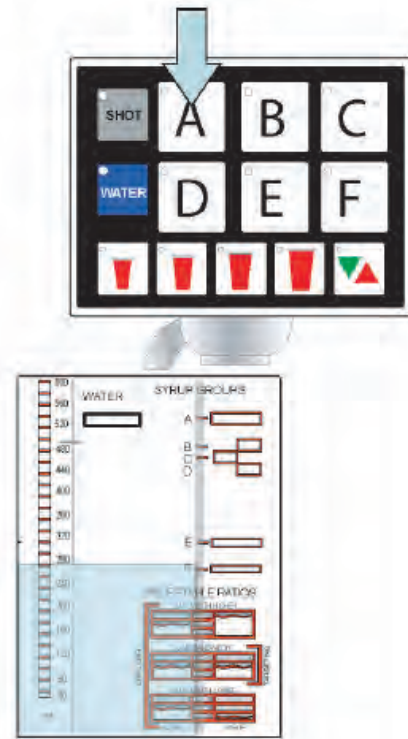

2.6 RATIO PROCESS

A. Remove outer nozzle and insert MVU separator if not done on previous step.

B. Prime separator by running the valve.

C. Press and fill the ratio cup to the appropriate levels.

D. Check/adjust ratio on each brand.

1. Use flow controls to adjust syrup.

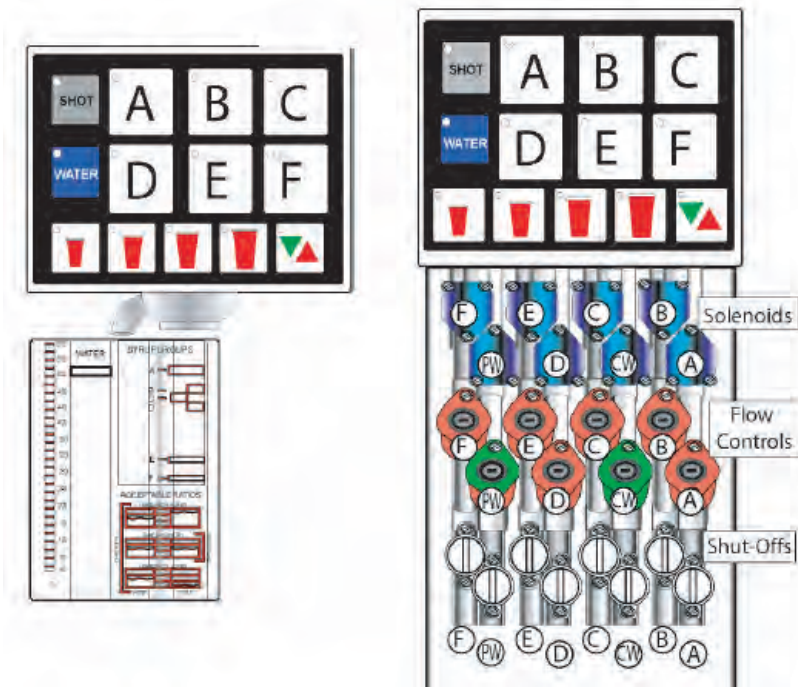

2.7 PORTION CONTROL PROGRAMMING (MVU) (NO TOP-OFF)

A. Press the S and XL at the same time for five seconds to enter the portion setting mode.

1. The Pour/Cancel light will illuminate and the shot light will blink two times.

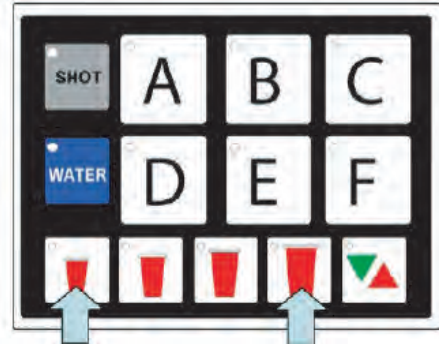

Press the Brand button.

1. The selected brand's LED will illuminate.

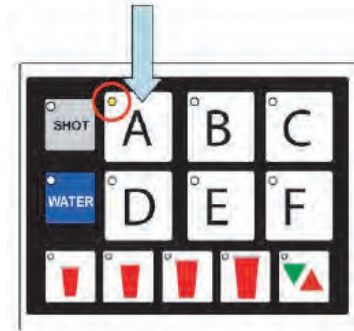

2. Multiple brands can be programmed at the same time to pour the same amounts for each size during this step.

Do this by selecting several brand buttons; however, the first button selected will illuminate and only its beverage will pour. The other brands selected will flash slowly.

3. If multi-brand programming, do not set carbonated drinks and non-carbonated drinks at the same time because carbonated drinks will foam.

NOTE: The LED will blink twice and turn off if the brand has been programmed as a flavor shot instead of a drink. You will need to reprogram the brand as a drink prior to setting the portion.

C. Fill cup 1/3 full with ice and place it under the nozzle, push and hold a drink "size" button until the cup is full.

1. Once the pour is completed, the LED will blink slowly to indicate that a new pour duration has been programmed for that key.

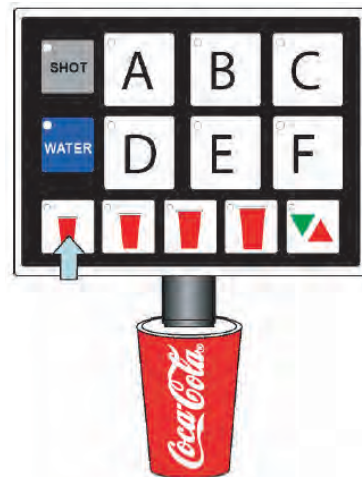

D. Repeat this step for each of the other size cups.

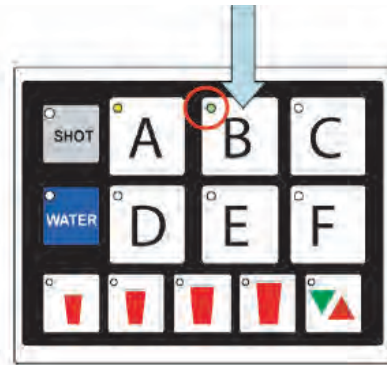

E. Select other brands and repeat these steps for each of them.

F. Press the “Pour/Cancel” button to save programming.

NOTE: The Program will save automatically in 60 seconds if no additional changes are made in that time frame; however, you can exit any time within the 60 second window by pressing Pour/Cancel. The changes you’ve made will be saved.

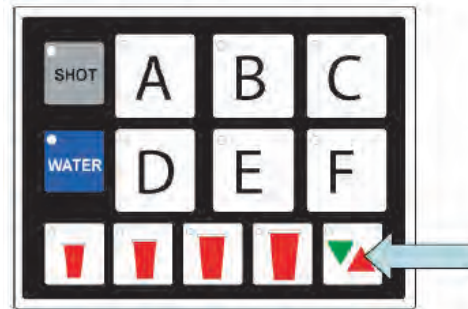

2.8 PORTION CONTROL PROGRAMMING WITH TOP-OFF (MVU)

A. Press the S, L, and Pour/Cancel buttons at the same time for two seconds to enter portion setting mode.

1. The Pour/Cancel light will illuminate and the shot light will blink three times.

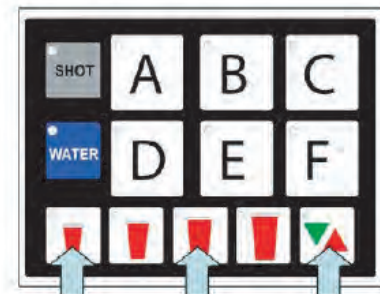

B. Press the brand button.

1. The selected brand's LED will illuminate.
2. Multiple brands can be programmed at the same time to pour the same amounts for each size during this step. Do this by selecting several brand buttons; however, the first button selected will illuminate and only its beverage will pour. The other brands selected will flash slowly.
3. If multi-brand programming, do not set carbonated drinks and non-carbonated drinks at the same time because carbonated drinks tend to pour faster.

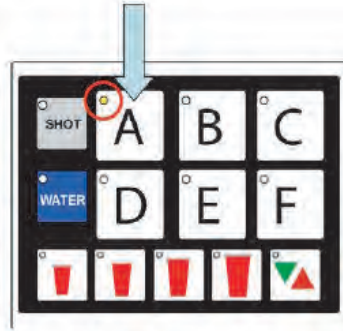

C. Fill cup 1/3 full with ice.

D. Place cup under the nozzle, push and hold a drink "size" button until the cup is full.

1. Once the pour is completed, the LED will blink fast to indicate Settle Time programming mode.
2. If the duration is more than 40 seconds, the dispense function is stopped and the portion is not saved.

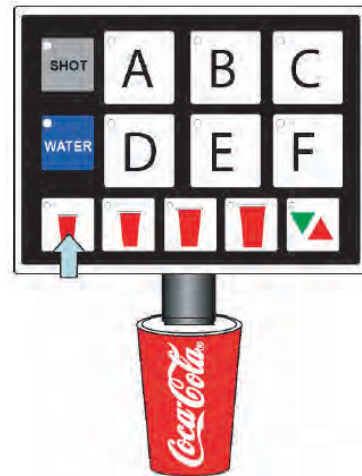

E. After beverage settles, press the Size button again to top off the drink.

1. If the settle time is more than fifteen seconds, the auto top-off times are cleared for all selected flavors.

F. Repeat steps B-E for additional brands and cup sizes.

G. Press Pour/Cancel button to save the portions and exit programming mode.

1. If no button is pressed in 60 seconds, the system will exit program mode and save the current programming.
2. The Pour/Cancel will blink until the program is saved.

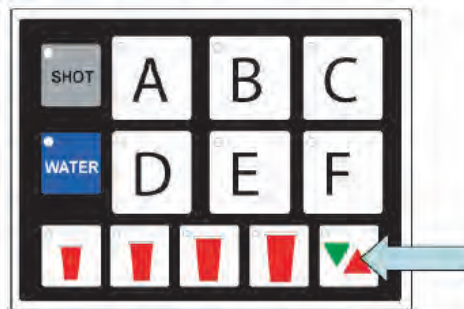

2.9 SHOT SIZE PROGRAMMING

Flavor shot portions can be adjusted using the MVU touchpad and a graduated cylinder. To adjust flavor shots:

- A. While in Portion Control Programming, press the Shot button.
1. Pressing the Shot button again will exit Shot Size Programming.

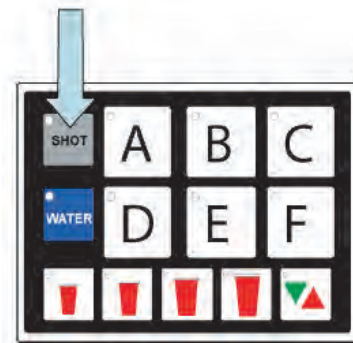

- B. Press a "Brand" button. The brand button will illuminate.

NOTE: If brand is not enabled for shot mode, the LED light on that brand will blink twice and turn off.

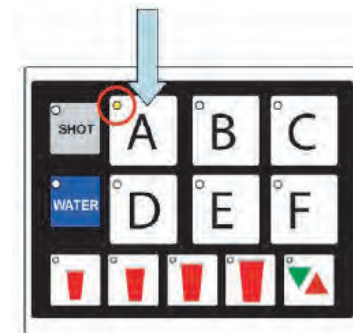

- C. Place a graduated cylinder under the nozzle.
- D. Press and hold the XL portion button until the portion size is achieved. Target is 30 ml (1 Oz) of syrup for an XL portion for most customers.
1. The XLRG LED will blink slowly to indicate that a new shot duration has been programmed.

NOTE: The other size buttons are proportioned automatically based on the amount poured in XL mode:

Small = 25% of XL portion

Medium = 50% of XL portion

Large = 75% of XL portion

- E. Repeat steps B through D for each of the other brands.

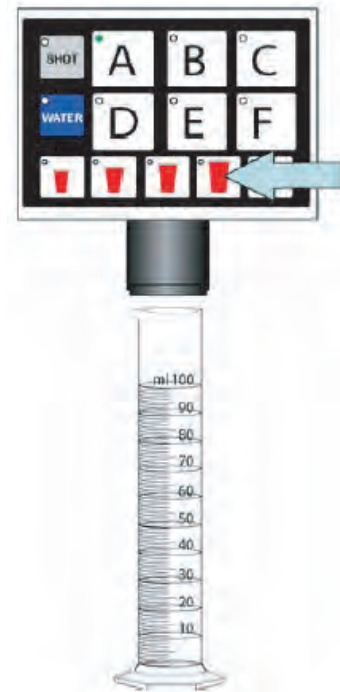

F. Press Pour/Cancel to save the settings.

NOTE: The Program will save automatically in 60 seconds if no additional changes are made in that time frame; however, you can exit any time within the 60 seconds window by pressing Pour/Cancel. The changes you've made will be saved.

2.10 DISPENSER OPERATION

Crew Serve Beverage Dispensing

Flavor Shot Dispensing - Portion Control

- A. Place cup under MVU nozzle.
- B. Press the "Shot" button.
 - 1. The "Shot" LCD will stay illuminated (active) for 10 seconds.
- C. Select Brand Button.
 - 1. Brand will stay illuminated for up to ten seconds.
 - 2. Touch brand again to deactivate.
- D. Select portion control size button to begin dispensing flavor shot.
 - 1. Press "Pour/Cancel" to stop dispense mode.

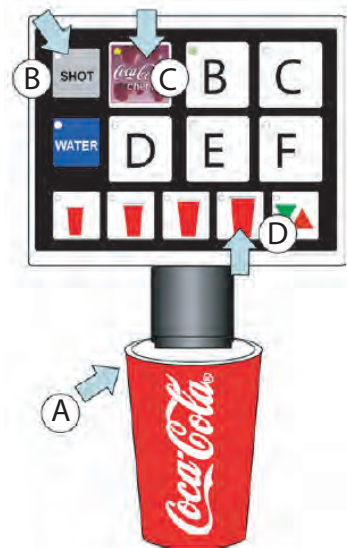

Beverage Dispensing - Portion Controlled

- A. Press the brand button.
 - 1. Button stays active for 10 seconds or until another brand is pressed.
- B. Press a portion control size button.
 - 1. Beverage will pour.
 - 2. Press the Pour/Cancel to stop pour prior to complete dispense.

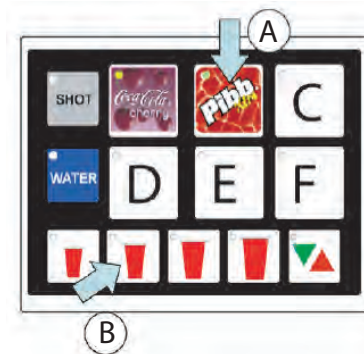

Beverages - Manual Dispense on Portion Control

A. Press the brand button.

1. Button stays active for ten seconds or until another brand is pressed.

B. Press and hold the pour/cancel button.

1. The beverage continues to pour until the button is released.
2. The selection will stay in memory for ten seconds.
3. The valve can pour for a maximum of thirty seconds.

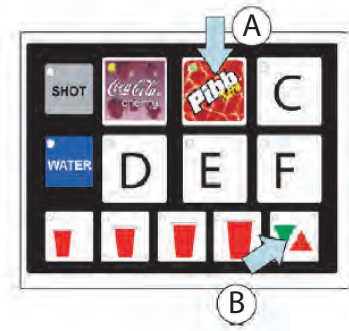

2.11 FINAL ASSEMBLY

A. Reinstall the front cover plate.

B. Reinstall drip tray, splash plate and cup rest. System is ready for operation.



3. RECOMMENDED SERVICE AND MAINTENANCE

3.1 SCHEDULED

- A. Daily – See Section 3.4 for daily cleaning.
- B. Monthly – See Section 3.5 for monthly cleaning.
- C. Periodic Sanitizing - See sections 3.2 and 3.3 for sanitizing requirements.
- D. As needed - Keep exterior surfaces of dispenser (including drip tray and cup rest) clean with a damp, clean cloth.

3.2 CLEANING AND SANITIZING SYSTEMS

A. General Information

- (1) Lancer equipment (new or reconditioned) is shipped from the factory cleaned and sanitized according to NSF guidelines. The operator of the equipment must provide continuous maintenance as required by this manual and state and local health department guidelines to maintain proper operation and sanitization.

NOTE: The cleaning and sanitizing procedures below pertain to the Lancer equipment identified by this manual. If other equipment is being cleaned, follow the guidelines established for that equipment.

- (2) Cleaning and sanitizing should be accomplished only by trained personnel. Use sanitary gloves during cleaning and sanitizing operations. Observe all safety precautions. Follow instruction warnings on the cleaning product.



WARNING!

To avoid contamination, do not disconnect water lines when cleaning and sanitizing syrup lines.

- (3) Recommended Preparation of Cleaning Solutions.

- (a) Cleaning solutions (for example, Ivory Liquid, Calgon, etc.) mixed with clean, potable water at a temperature of 90 to 110 degrees Fahrenheit should be used to clean equipment. The mixture ratio, using Ivory Liquid, is one ounce of cleanser to two gallons of water. A minimum of four gallons of cleaning mixture should be prepared.

NOTE: Extended lengths of product lines may require that an additional volume of solution be prepared.

- (b) Any equivalent cleanser may be used as long as it provides a caustic-based, non-perfumed, easily-rinsed mixture containing at least two percent sodium hydroxide (NaOH).

- (4) Recommended Preparation of Sanitizing Solutions.

- (a) Sanitizing solutions should be prepared according to the manufacturer's written recommendations and safety guidelines. Follow manufacturer's requirements so that the solution provides 200 parts per million (PPM) chlorine at a temperature of 90°F to 120°F. Prepare a minimum of four gallons of sanitizing solution.

NOTE: Extended lengths of product lines may require that an additional volume of solution be prepared.

- (b) Any sanitizing solution may be used as long as it is prepared according to the manufacturer's written recommendations and safety guidelines, and provides 200 parts per million (PPM) chlorine.

3.3 CLEANING AND SANITIZING BAG-IN-BOX (BIB) SYSTEMS

- A. Disconnect syrup quick disconnect coupling from syrup packages and connect coupling to a bag valve removed from an empty Bag-in-Box package.
- B. Place end of syrup inlet line, with bag valve attached, in a clean container filled with clean, potable, room-temperature water.
- C. Place waste container under applicable dispensing valve. Activate valve until water is dispensed. Flush and rinse line and fittings for a minimum of 60 seconds to remove all traces of residual product.

NOTE: Extended lengths of product lines may require additional time for flushing and rinsing lines.

- D. Prepare cleaning solution as described in Section 3.2 above. Place end of syrup inlet line in container filled with cleaning solution.
- E. Place waste container under applicable dispensing valve. Activate valve and draw cleaning solution through lines for a minimum of sixty seconds. This will ensure line is flushed and filled with cleaning solution. Allow line to stand for at least thirty minutes.
- F. Place end of syrup inlet line in a clean container filled with clean, potable water at a temperature of 90 to 110 degrees F.
- G. Place waste container under applicable dispensing valve. Activate valve to flush and rinse line and fittings for a minimum of sixty seconds to remove all traces of cleaning solution. Continue rinsing until testing with phenolphthalein shows that the rinse water is free of residual detergent.
- H. Prepare sanitizing solution as described in Section 3.2 above. Place end of syrup inlet line in container filled with sanitizing solution which has been prepared.
- I. Activate valve and draw sanitizing solution through line for a minimum of sixty seconds. This will ensure line is flushed and filled with sanitizing solution. Allow line to stand for at least fifteen minutes.
- J. Remove bag valve from quick disconnect coupling and reconnect syrup inlet line to syrup package. Ready unit for operation.



WARNING!

Flush sanitizing solution completely from syrup systems. Residual sanitizing solution creates a health hazard.

- K. Draw drinks and refill lines with end product to flush sanitizing solution from the dispenser.

NOTE: A fresh water rinse cannot follow sanitization of equipment. Purge only with the end use product. **This is an NSF requirement.**

- L. Test dispenser in the normal manner for proper operation. Taste dispensed product to ensure there is no off-taste. If off-taste is found, flush syrup system again.
- M. Repeat cleaning, rinsing, and sanitizing procedures for each valve circuit.

3.4 VALVES

- A. Valves may be cleaned and sanitized (see preparation in Section 3.2) in the same manner.
 - 1. Remove cover and disconnect power so the valve will not be activated during the cleaning procedure. Remove nozzle and diffuser. Wash these parts in cleaning solution, then immerse them in a bath of sanitizing solution for 15 minutes.
 - 2. Visually inspect around nozzle area for syrup residue. This area may be cleaned with warm water and cloth or with the nozzle brush supplied. Wipe off dispensing lever.
 - 3. Wearing sanitary gloves, remove, drain and air dry the nozzle and diffuser.
 - 4. Wearing sanitary gloves, replace diffuser, twist nozzle in place.
 - 5. Connect power and replace cover. Valve is ready for operation.

3.5 ICE BIN COMPARTMENT ON ALL ICE CHESTS

- A. Clean and sanitize the ice bin compartment of the dispenser thoroughly at least once every month. Use the following procedure:
- B. Prepare cleaning solution and sanitizing solution described in Section 3.2.
- C. Using the cleaning solution and a clean soft cloth, wash down the sides of the ice bin and the surface of the aluminum casting.
- D. Using clean, potable water, thoroughly rinse away the cleaning solution from the sides and surface of the casting.
- E. Using plastic sanitary gloves, soak a white cotton gauze cleaning rag in the sanitizing solution and wipe all surfaces in the ice compartment.

NOTE: A fresh water rinse cannot follow sanitization of equipment. Purge only with the end-use product. **This is an NSF requirement.**

- F. Sanitizing of the ice compartment is complete. Refill with ice.

4. TROUBLESHOOTING

<u>TROUBLE</u>	<u>CAUSE</u>	<u>REMEDY</u>
4.1 No carbonation.	<p>A. Carbonator motor not running.</p> <p>B. Absence of CO₂ gas.</p> <p>C. Gas only from valves.</p> <p>D. Carbonator tank air bound.</p> <p>E. CO₂ gas pressure below 75 PSI.</p> <p>F. Carbonator motor running continuously.</p> <p>G. Water pump not moving water.</p> <p>H. Ice on cold plate.</p>	<p>A. Check power supply to see if plugged in. Check if LED light is blinking. If so, reset by unplugging and re-plugging power supply.</p> <p>B. Replace with full tank of CO₂ gas.</p> <p>C. Check for power failure. Check fuses. Clean strainer on pump.</p> <p>D. Relieve gas pressure in tank by flipping up relief valve until water spurts out.</p> <p>E. Reset high pressure CO₂ gas regulator to 75 PSI. Change CO₂ tank if required.</p> <p>F. Inspect check valve for blockage. Check carbonator control. Check carbonator pump for efficiency.</p> <p>G. Replace water pump if necessary.</p> <p>H. Fill bin with ice.</p>
4.2 Noisy carbonator pump.	<p>A. Insufficient water supply or water leak allowing air to be pulled into pump.</p> <p>B. Loose pump coupling.</p>	<p>A. Provide adequate water supply. Ensure strainer is clean.</p> <p>B. Tighten set screw on pump coupling.</p>
4.3 Valves inoperable.	<p>A. Loss of power.</p> <p>B. Faulty bin switch.</p>	<p>A. Check power supply to see if plugged in. Check transformer circuit breaker. Check main power circuit breaker, 110V. Check keylock switch on side of tower to ensure it is in the "ON" position.</p> <p>B. Ensure proper connection.</p>

CONTINUED ON NEXT PAGE

TROUBLE**CAUSE****REMEDY**

4.4 LED blinking 4 blinks per second.	A. No water to pump.	A. Ensure water supply is on, carbonator pump motor is connected, and probe is not damaged. Reset by unplugging and re-plugging power supply.
4.5 LED blinking 1 blink per second.	A. Short in probe. B. Short in harness. C. Crossed wires in harness or probe plug.	A. Replace probe. B. Replace harness. C. Correct wiring (see CCNA Bulletin Serv 256).

NOTES

5. ILLUSTRATIONS, PARTS LISTINGS, AND WIRING DIAGRAMS

5.1 SERIES 2300 DROP-IN

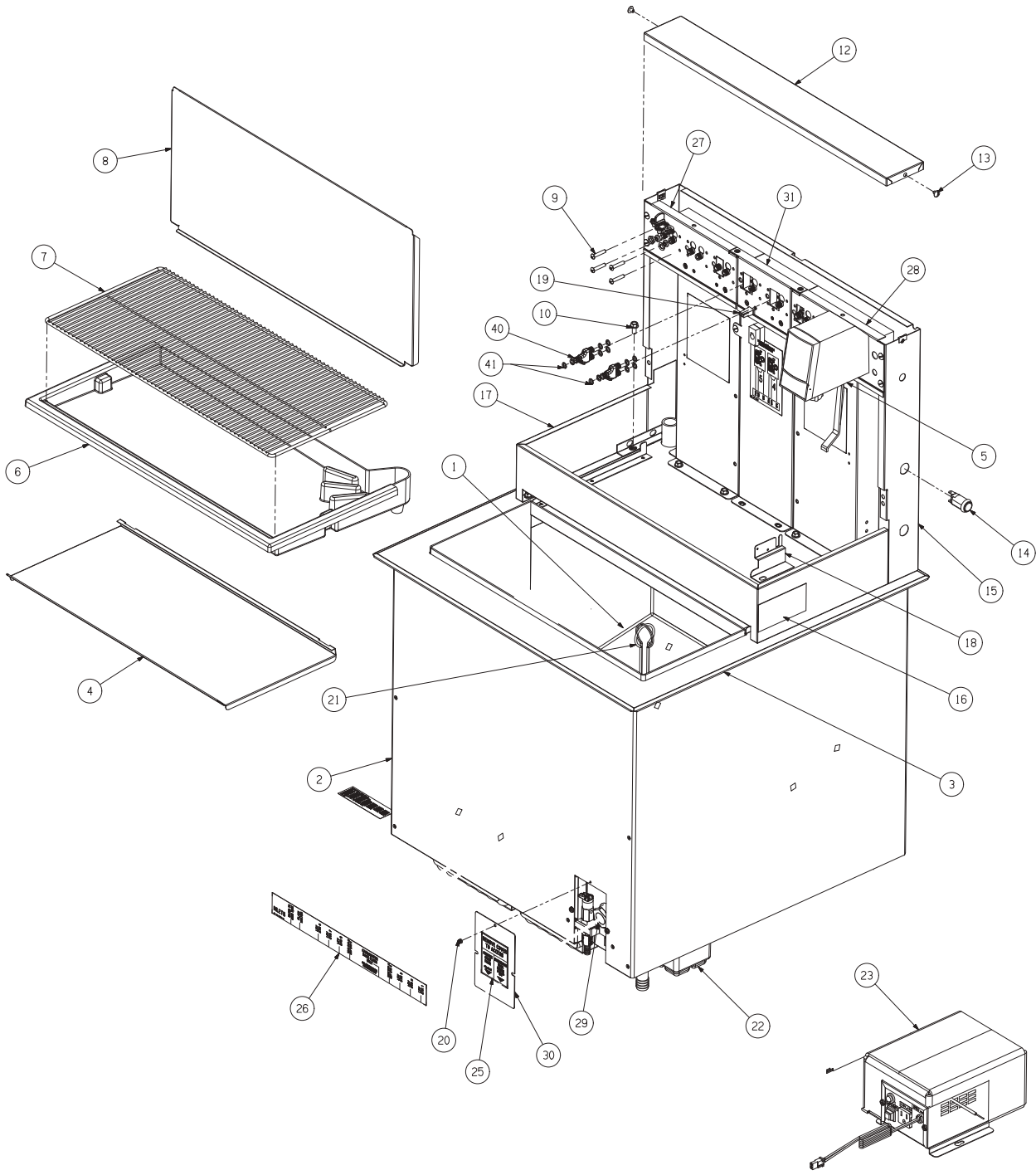

5.1 SERIES 2300 DROP-IN - PARTS LIST

ITEM	PART NO.	DESCRIPTION
1	42-0100	Tank Assy, High Performance
-	30-9231	Liner, Tank Wrapper, Back
2	30-10057	Tank Wrapper
3	51-6225	Rim Assy
4	30-9267	Lid, Ice Bin
5	19-0353/02	LEV ®, 4.5, Portion Control
6	05-2586	Drip Tray
7	23-0797/02	Cup Rest
8	30-5424	Splash Plate
9	04-1089	Screw, 10 - 32 X 1.000 (for LEV ® only)
10	04-1537	Screw, 1/4-20 x .500
11	48-0776	Foamed Manifold (5 Valve, 4-1)
-	48-0767	Foamed Manifold (6 Valve, 5-1)
-	48-0851	Foamed Manifold (5 Valve, 2-1-2)
-	48-0850	Foamed Manifold (6 Valve, 3-1-2)
12	30-5986	Tower Cap
13	04-0148	Screw, 10 - 32 X 0.250
14	12-0097	Key Lock Switch Assy
15	51-6256	Tower Body (Stainless Steel)
16	06-0075-01	Nameplate (8 Valve)
17	51-5541	Base Assy.
18	30-10095	Bracket, Switch
19	11-0015	Housing Socket
20	04-0072	Rivet
21	23-0862	Wire Drain Assy
22	05-2583	Shipping Leg Plastic
23	82-1103	Transformer Assy
24	50-0475	Insulation Gasket LT
-	50-0476	Insulation Gasket RT
25	06-3069	Label, VLU/Probe
26	06-3070	Label WTR/SYR Inlets
27	23-1452	Tower Structure Left
28	23-1453	Tower Structure Right
29	52-3075	Probe Assy
30	30-9871	Cover, Probe
31	23-1200-41	Tower Structure Center
32	54-0066	Relief Valve Sub-Assy, Plastic
-	82-3914	Tower Structure MVU
33	01-2673	Fitting Sub-Assy, CO ₂ -in
34	03-0021	Spring, Check Valve
35	02-0003	O-Ring
36	01-0674	Ball
37	01-0689	Sleeve
38	02-0005	O-Ring
39	01-2647	Body, Check Valve
40	01-2682	Fitting Converter
41	02-0005	O-Ring

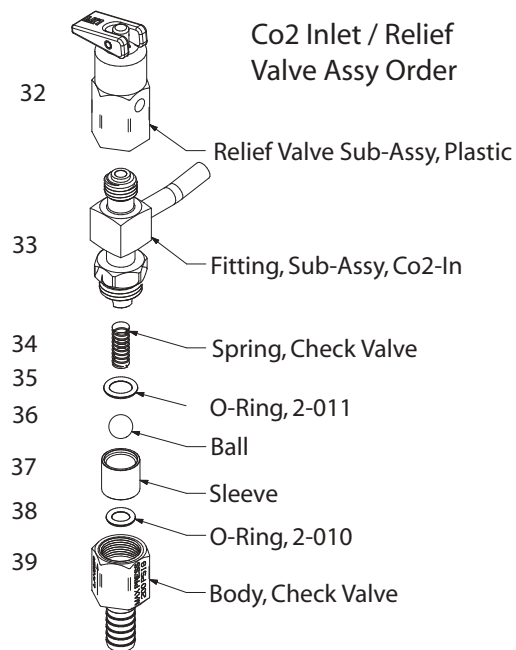

5.2 REMOTE PUMP ASSEMBLY

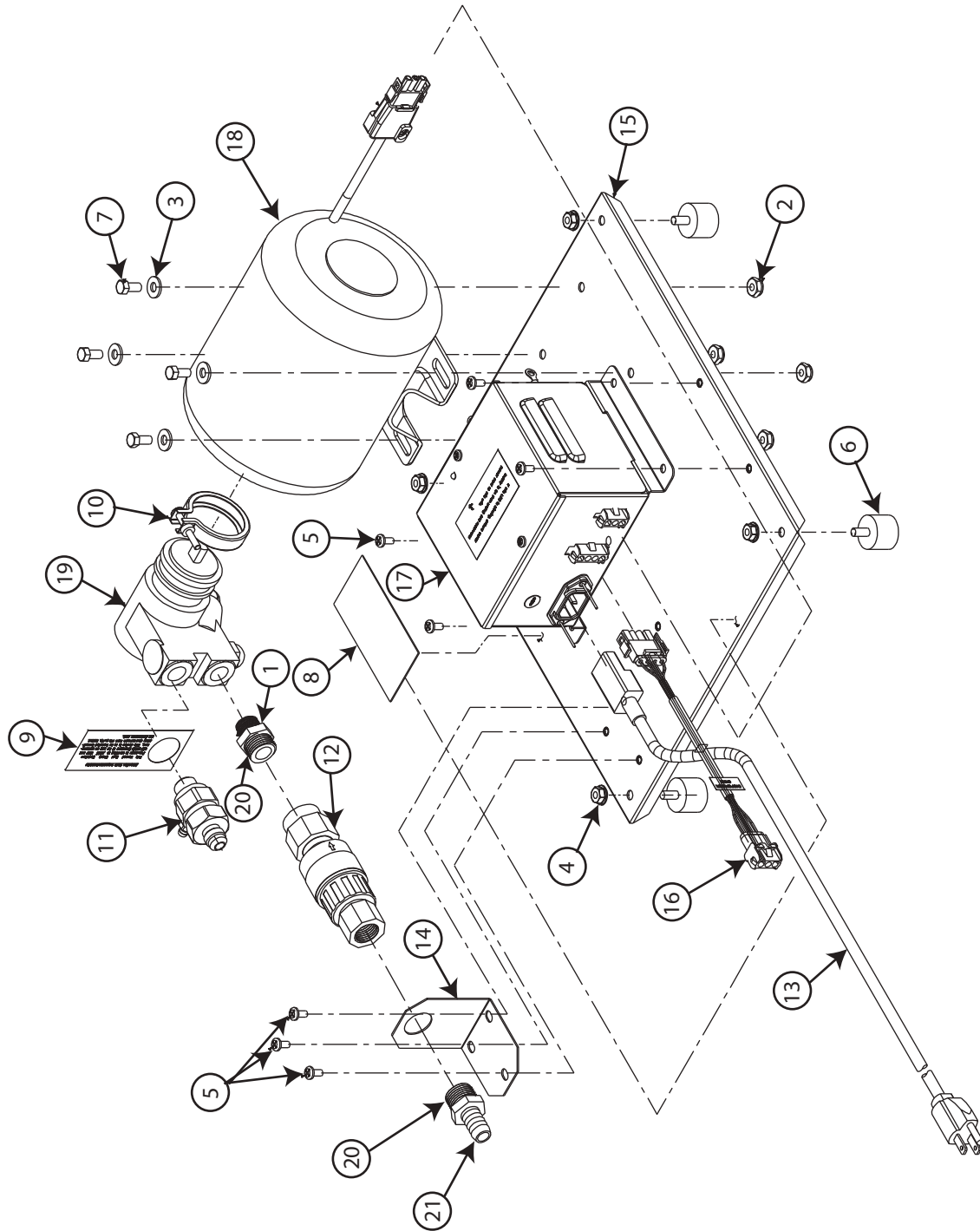

5.2 REMOTE PUMP ASSEMBLY - PARTS LIST

<u>ITEM</u>	<u>PART NO.</u>	<u>DESCRIPTION</u>
1	01-2700	Adapter, Plastic, 1/2x3/8 Fitting
2	04-0032/01	Nut, Nylock, 1/4-20
3	04-0033/01	Washer, Flat, 1/4 x .062
4	04-0034	Nut, Lock, 1/4-20
5	04-0236	Screw, 10/21 x .375
6	04-0247	Isolator, 1/4-20
7	04-0520/01	Screw, 1/4-20 x .500
8	06-0075-1	Nameplate, Vinyl
9	06-3087	Label, Check Valve
10	07-0582	Clamp, Pump/Motor, SS
11	17-0611	Check Valve, Vented
12	18-0310	Regulator, Water
13	21-0752	Power Cord
14	30-10368	Bracket, Pressure Valve
15	30-10369	Plate, Base Pump
16	52-3062	Harness, Extension, 8 FT
17	82-3808	Enclosure Assy
18	82-3913	Motor Assy, Remote
19	86-0001	Pump, Procon, Brass
20	15-0035	Tape, Teflon
21	01-2701	Adapter, PL

5.3 TOWER ASSEMBLY, BEVARIETY MVU

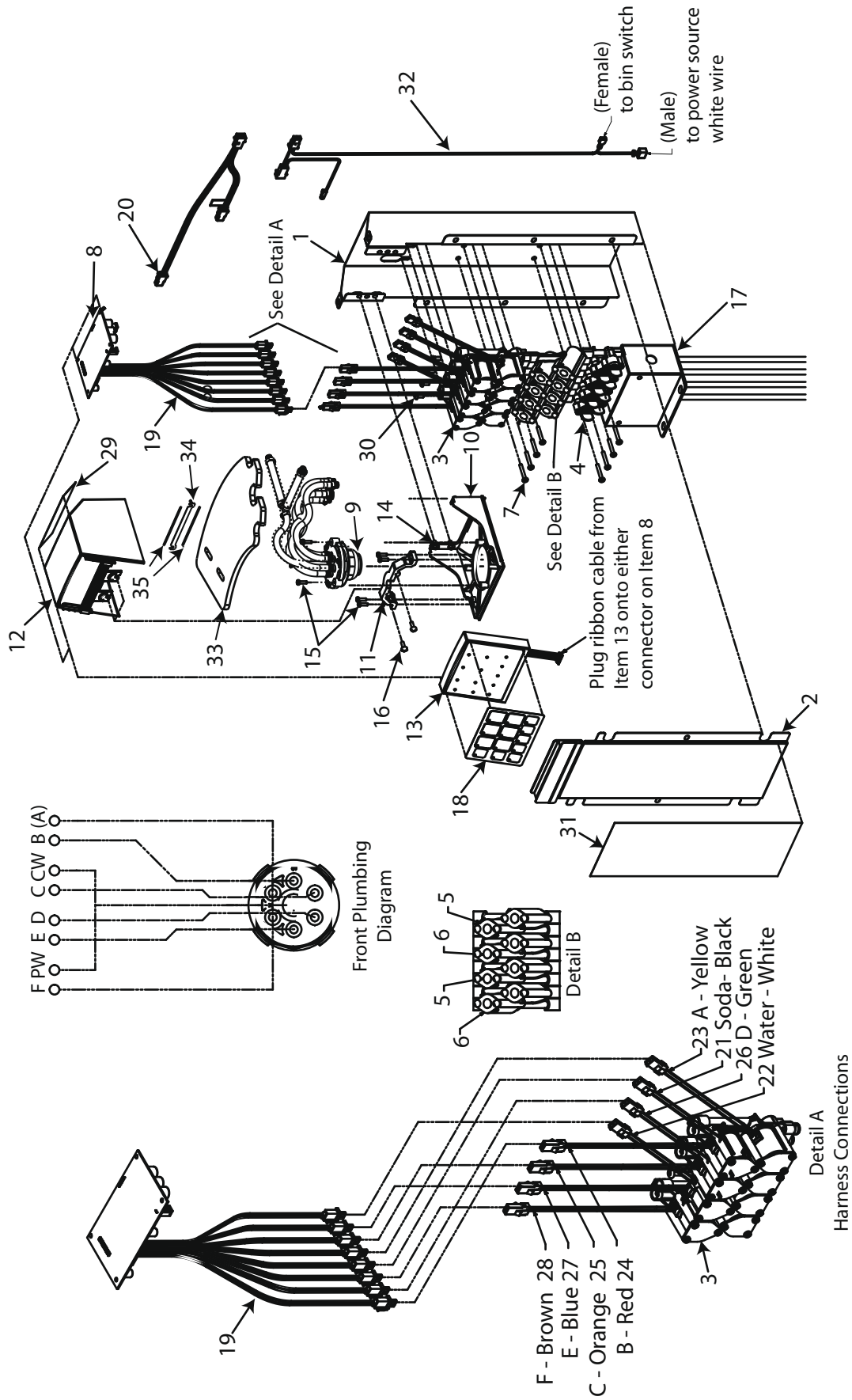

5.3 TOWER ASSEMBLY, BEVARIETY MVU - PARTS LIST

<u>ITEM</u>	<u>PART NO.</u>	<u>DESCRIPTION</u>
1	30-10098	Structure, MVU Tower
2	51-6259	Weldment Assy, Front Cover
3	17-0622-1	Body Assy, Solenoid, 2-Pack
4	17-0622-2	Body Assy, Shut-off, 2-Pack
5	17-0623-1	Body Assy, FC, 3.0, Syrup
6	17-0623-2	Body Assy, FC, 3.0, SY/WTR
7	04-0481	Scr, 8-32x1.125, PH, PH/SL, RL
8	64-5011/02	PCB Assy, Controller, MVU
9	49-0318/01	Sub-Assy, Nozzle, Bundled MVU
10	05-2687	Plate, Nozzle, MVU
11	05-2682	Bracket, Cover Mount, MVU
12	54-0464	Cover Assy, MVU
13	52-3160	Panel Assy, ID, MVU
14	04-0236	Scr, 10-24 x .375, PHD, PH, MS, S
15	04-0470	Scr, 6-19 x .500 PHD, PH/SL, PL
16	04-0267/02	Scr, 8-16 x .5, PLSTI, HHSW/SW, S
17	42-0161	Config Assy, FMD, 4A/2C, MVU
18	06-3077	Overlay, Button Board, MVU C
19	52-3169	Harness Assy, Solenoid, MVU/Bundle
20	52-3170	Harness Assy, Power, MVU/Bundle
21	06-0111	Label Soda
22	06-0112	Label Water
23	06-3127	Label, "A A A A"
24	06-3128	Label, "B B B B"
25	06-3129	Label, "C C C C"
26	06-3130	Label, "D D D D"
27	06-3131	Label, "E E E E"
28	06-3132	Label, "F F F F"
29	06-3111	Decal, Cover, Back, Bundle, MVU
30	04-0275	Scr, 8-16 x .427, THMD, PH, PLS
31	06-3125	Label, PLMB/Wire Diag, MVU
32	52-3200	Harness Assy, MVU, Bin Switch
33	50-0509/01	Insulation Foam, Nozzle Sonic
34	30-10429	Hose Bracket
35	15-0061	Grommet, Flexible

5.4 MVU ASSEMBLY

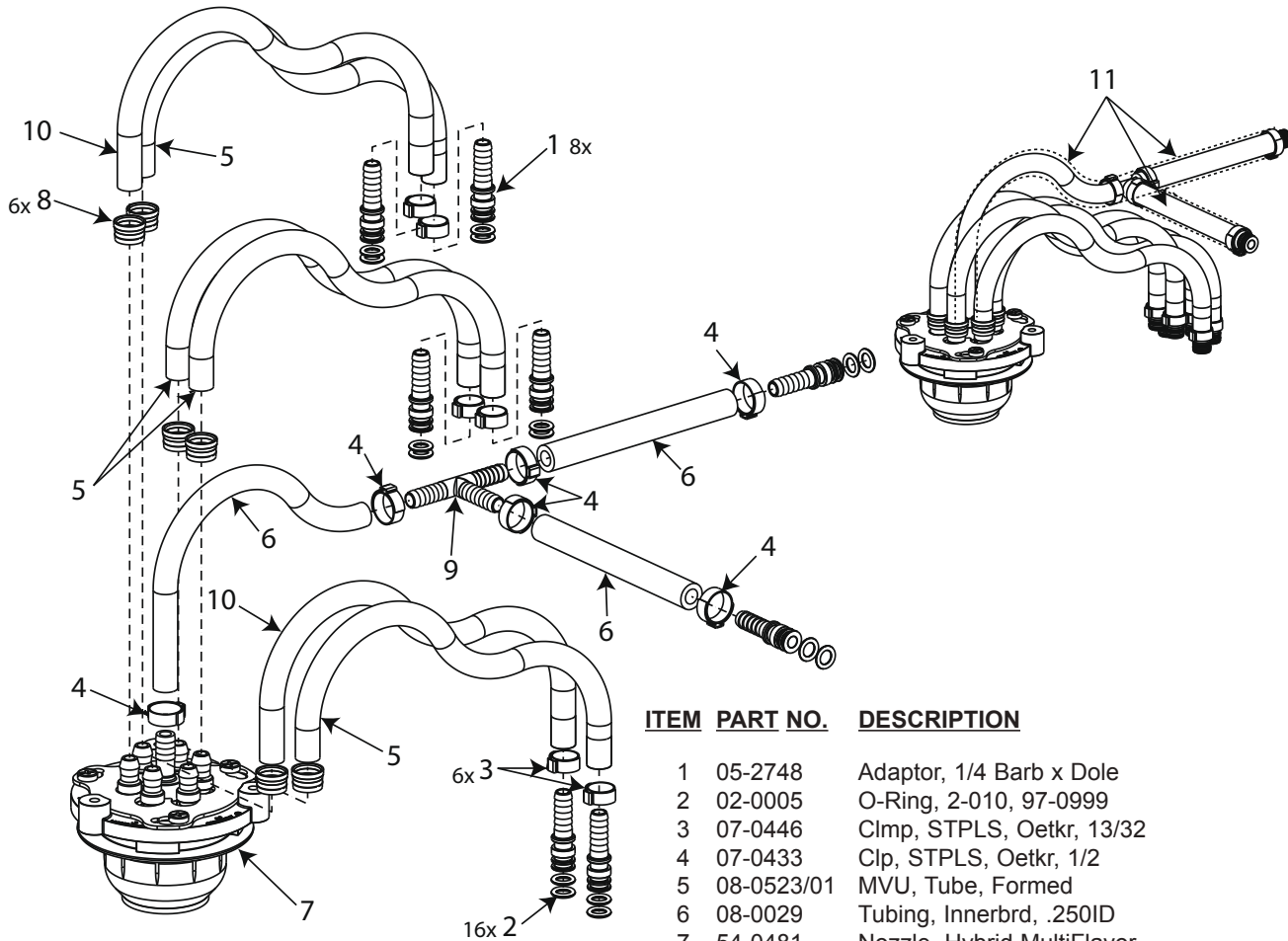

ITEM	PART NO.	DESCRIPTION
1	05-2748	Adaptor, 1/4 Barb x Dole
2	02-0005	O-Ring, 2-010, 97-0999
3	07-0446	Clmp, STPLS, Oetkr, 13/32
4	07-0433	Clp, STPLS, Oetkr, 1/2
5	08-0523/01	MVU, Tube, Formed
6	08-0029	Tubing, Innerbrd, .250ID
7	54-0481	Nozzle, Hybrid MultiFlavor
8	05-2766	Lock, Hose, HMFN
9	01-1280/01	Tee, SS, 1/4 Barb
10	08-0526/01	Tube, Formed, MVU, Inj, 4, 3
11	88-0013	Insul, Tubular, .375ID x .25
12	15-0012	Tape, Blk Duct, 2" (not shown) - wrap around Item 11 (insulation tube) junction.

5.5 NOZZLE, HYBRID MULTI-FLAVOR

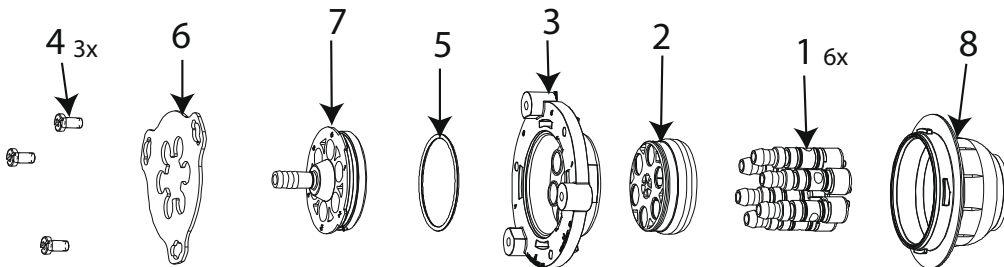

ITEM	PN	DESCRIPTION	ITEM	PN	DESCRIPTION
1	54-0480	Injector Assy, Syrup, HFMN, 4	5	02-0232	O-Ring, 2-030, 97-0999
2	05-2746/01	Nozzle, Body, Inner, HMFN	6	03-0449	Plate, Nozzle, Locking, HMFN
3	05-2745	Nozzle, Body, Main, HMFN	7	05-2693	Cap, Inlet, Water HMFN
4	04-0269	Scr, 8-16x.375, PHD, PH/SL, PL	8	05-2699	Outer Nozzle, Overmold, HMFN

5.6 ICE COOLED UNIVERSAL WIRING DIAGRAM WITH BIN LID SWITCH

ICE COOLED UNIVERSAL WIRING DIAGRAM WITH BIN LID SWITCH

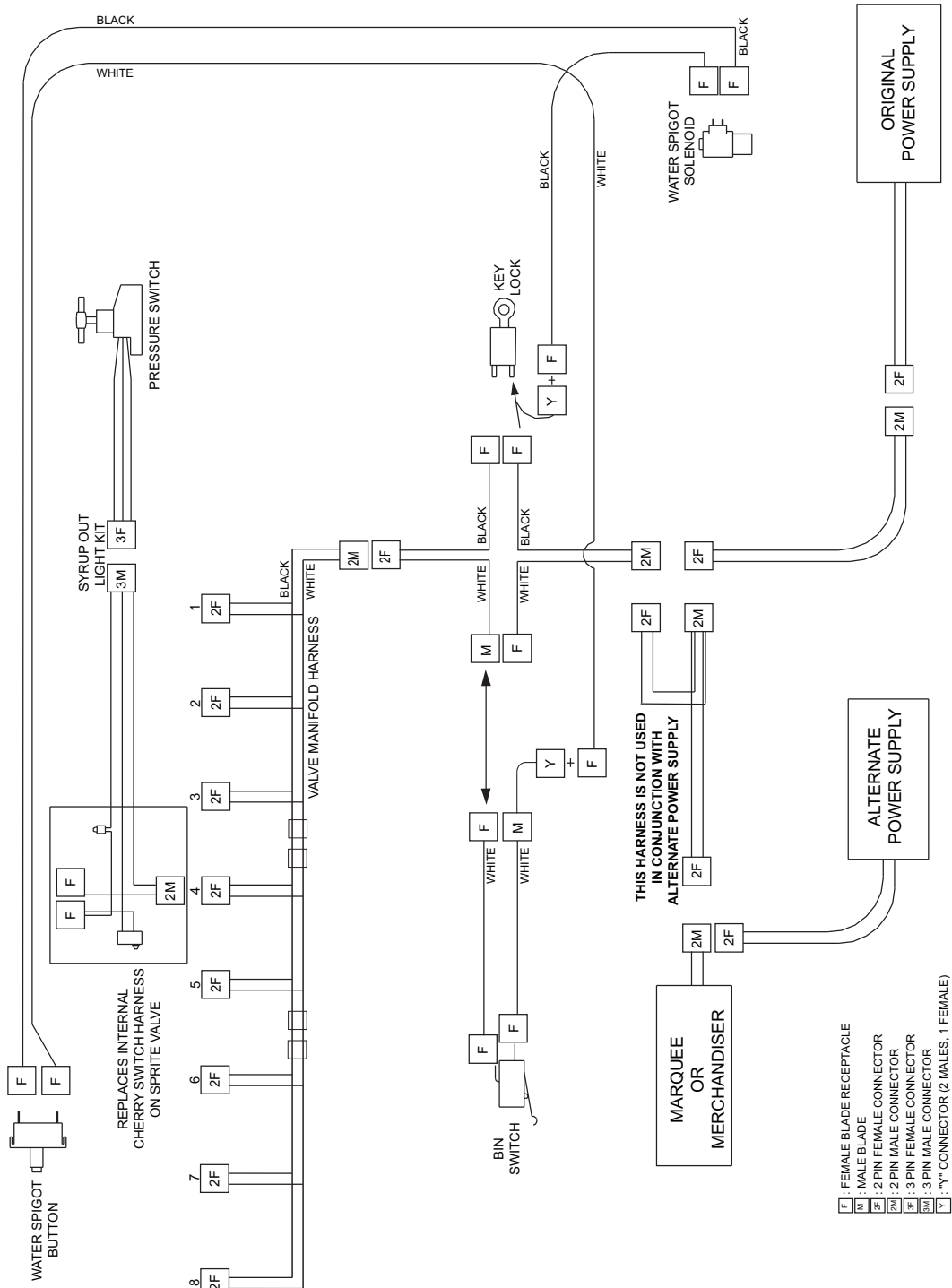

5.7 ICE COOLED UNIVERSAL WIRING DIAGRAM WITH BIN LID SWITCH AND MVU

ICE COOLED UNIVERSAL
WIRING DIAGRAM WITH BIN LID SWITCH

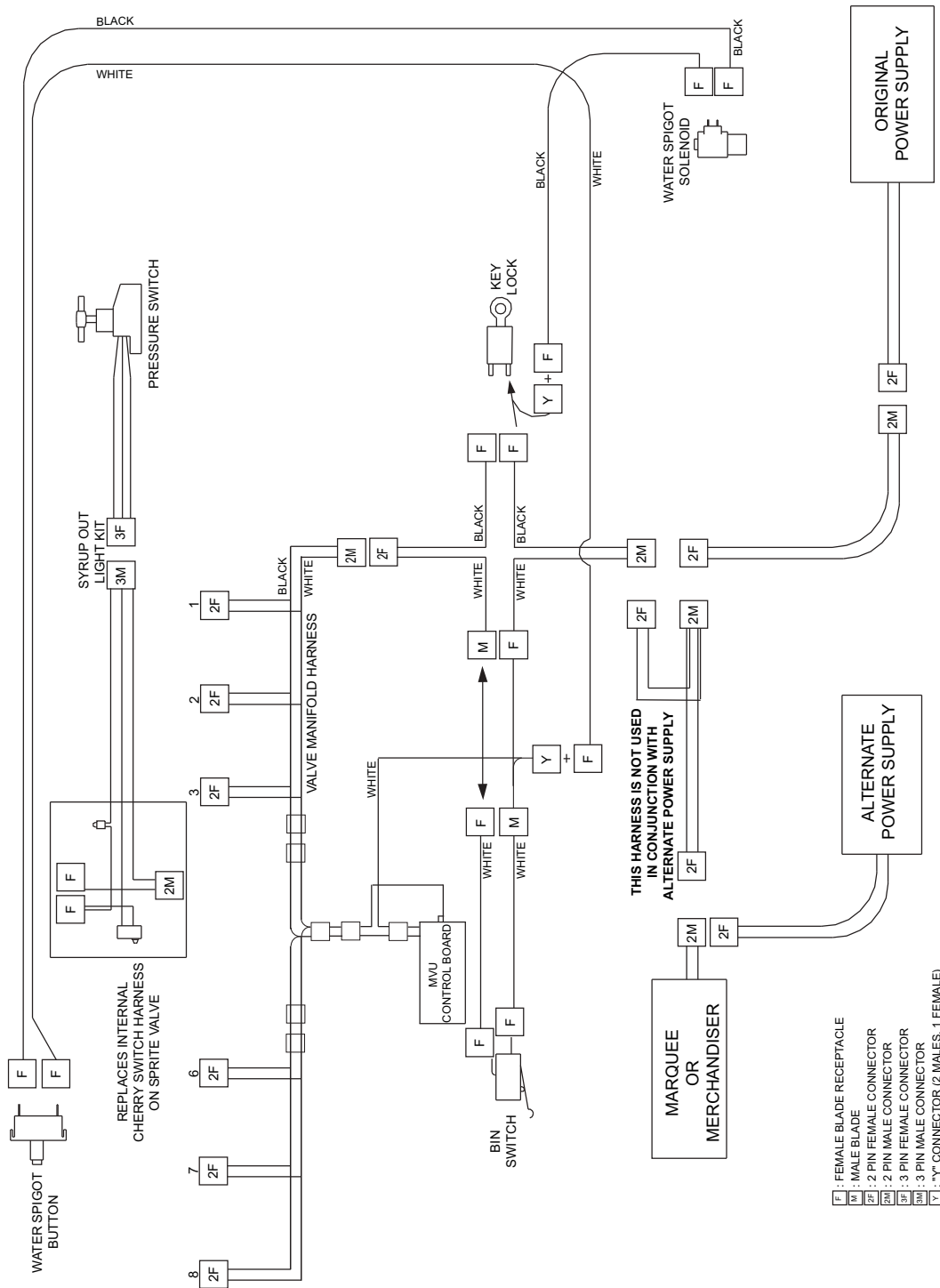

5.8 ACCESSORIES

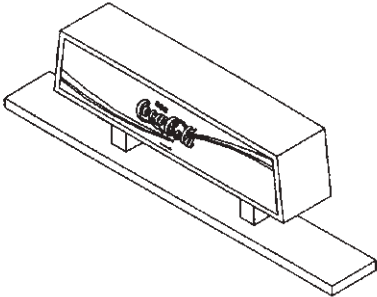

**Illuminated Merchandiser
PN 85-2304**

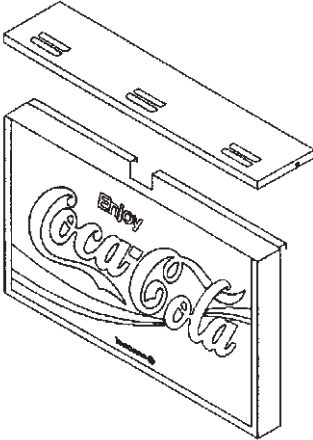

**Illuminated Marquee
PN 85-2302-20**

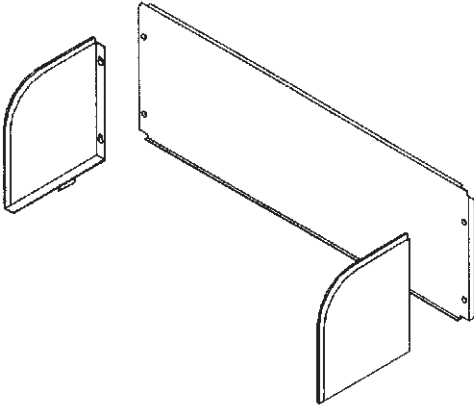

**Splash Guards Kit
PN 82-3899**

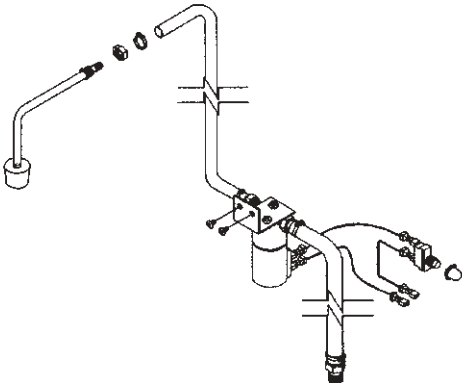

**Water Spigot for Ambient
Temperature Water Kit
PN 82-3903**



LANCER

To order parts, call

Customer Service: 800-729-1500

Warranty: 800-729-1550

Email: custserv@lancercorp.com

www.lancercorp.com